

# HAND

SOCKETS  
STECKSCHLÜSSEL  
DOUILLES À MAIN

1/4"

3/8"





















































1/2"









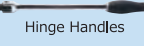

3/4"

1"

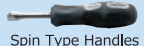
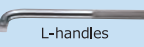

Hand Sockets  
Hand Steckschlüssel  
Douilles à main

Hand Sockets	Square Drive														
	1/4"(6.35mm)SQ.			3/8"(9.5mm)SQ.			1/2"(12.7mm)SQ.			3/4"(19mm)SQ.			1"(25.4mm)SQ.		
	No.		Page	No.		Page	No.		Page	No.		Page	No.		Page
 Standard Sockets	 6-point	2400M mm 48	2400A inch 48	2400W BA 49	3400M mm 68	3400A inch 68	3400W BSW 69	4401M/4400M mm 102	4400A inch 103	4400W BSW 104	6400M mm 130	6400A inch 130	8400M mm 136	8400A inch 136	
	 12-point	2405M mm 48	2405A inch 48	AS2405A inch 48	3405M mm 68	3405A inch 68	3405W BSW 69	4406M/4405M mm 102	4405A inch 103	4405W BSW 104	6405M mm 130	6405A inch 130	8405M mm 136	8405A inch 136	
	 Surface	2410M mm 49			3410M mm 69			4410M mm 104							
	 NUT GRIP®	2450MS mm 50	2450AS inch 50		3450M mm 71	3450A inch 71	3450MH mm 71	4450M mm 106							
	 NUT GRIP® (3-ball)	2455AS inch 50													
	 TORX® (E)	2425 TORX® 51			3425 TORX® 70			4425 TORX® 105	4425-N TORX® 104		6425 TORX® 130				
	 TORX® (E) (NUT GRIP®)				3425(2B) TORX® 71										
	 TORXplus® (EP)							4425-EPL TORXplus® 105							
	 TORXplus® (EPR)							4425-EPRL TORXplus® 105							
	 LH-S				3400LH LH-STIX® 70			4400LH LH-STIX® 106							
	 Double Square	2415M mm 49	2415A inch 49		3415M mm 70	3415A inch 70									
 Semi Deep Sockets	 6-point	2300X mm 51			3300X mm 72	3300XA inch 72									
	 12-point				3305X mm 72	3305XA inch 72									
	 NUT GRIP®	2350X mm 51			3350X mm 72										
 Deep Sockets	 6-point	2300M mm 52	2300A inch 52	2300W BA 53	3300M mm 73	3300A inch 73	3300W BSW 74	4300M mm 107	4300A inch 107		6300M mm 131	6300A inch 131			
	 12-point	2305M mm 52	2305A inch 52	AS2305A inch 52	3305M mm 73	3305A inch 73	3305W BSW 74	4305M mm 107	4305A inch 107		6305M mm 131	6305A inch 131			
	 Surface	2310M mm 53			3310M mm 74			4310M mm 108							
	 NUT GRIP®	2350M mm 53			3350M mm 75										
	 TORX® (E)	2325 TORX® 53			3325 TORX® 75			4325 TORX® 108							
	 Flare Nut				3300FN mm 75										
	 Extra Deep Sockets	 6-point				3300M(L120) mm 76			4300M(L120) mm 109						
	 12-point				3305M(L120) mm 76										
	 NUT GRIP®				3350M(L120) mm 76	3350A(L120) inch 76									
	 TORX® (E)						4325(L140) TORX® 109								
	 TORX® (E) (NUT GRIP®)						4325(L140)-2B TORX® 109								
 Extension Sockets	 12-point				3117M mm 79			4117M mm 109							
 Universal Sockets	 6-point	2440M mm 54	2440A inch 54		3440M mm 77	3440A inch 77		4440M mm 110	4440A inch 110						
	 12-point	2445M mm 54	2445A inch 54	AS2445A inch 54	3445M mm 77	3445A inch 77	3445W BSW 77	4445M mm 110	4445A inch 110						
	 NUT GRIP®	2441M mm 54			3441M mm 78										
	 TORX® (E)	2440T TORX® 54			3440T TORX® 77			4440T TORX® 110							
 Universal Deep Sockets	 6-point				3340M mm 78										
 Bit Sockets	 PH	2000 PH 55			3000 PH 80			4000 PH 110							
	 PZ	2000(PZ) PZ 55			3000(PZ) PZ 80			4000(PZ) PZ 110							
	 Slotted	2005 Slotted 55			3005 Slotted 80			4005 Slotted 110							
	 Hexagon	2010M mm 56	2010A inch 56		3010M mm 81	3010A inch 81	3012M mm 82	3012A inch 82	4010M mm 111	4010A inch 111	6012M mm 131	4012M mm 112	4012A inch 113	8012M mm 137	
	 Hexagon (Grip Ring)				3015M mm 83										
	 Hexagon (Ball Point)	2011M mm 56			3011M mm 83										
	 XZN (Triple Square)	2020 XZN 57			3020 XZN 84			4020 XZN 114							
	 TORX® (T)	2025(T) TORX® 57			3025(T) TORX® 85			4025(T) TORX® 115							
	 TORX® (TH)	2025(TH) TORX® 57			3025(TH) TORX® 86										
	 TORXplus® (IP)	2025(IP) TORXplus® 58			3025(IP) TORXplus® 87			4025(IP) TORXplus® 116							
	 TORXplus® (IPR)	2025(IPR) TORXplus® 58			3025(IPR) TORXplus® 88										
	 Ribe CV				3027 Ribe CV 88			4027 Ribe CV 116							
 Universal Bit Sockets	 Hexagon	2430M mm 55			3430M mm 79										
	TORX® (T)	2430T TORX® 55													

Handles/Accessories		Square Drive									
		1/4"(6.35mm)SQ.		3/8"(9.5mm)SQ.		1/2"(12.7mm)SQ.		3/4"(19mm)SQ.		1"(25.4mm)SQ.	
		No.	Page	No.	Page	No.	Page	No.	Page	No.	Page
 Ratchet Handles	Standard	2753 series	59-60	3753 series 3752 series	91-92 91	4753 series 4750 series 4752 series	120 119 118	6749 6752	132 132	8749	138
	Short	2753PS	59	3749S series	90						
	Long	2753P-160	59	3753P-250	91	4749-380 series 4753P-410	121 121	6749-1000	132	8749-1000	138
	Compact			2749-3/8 series	90	3749S-1/2 series	118				
	Others			3753SM series 3757	90 95						
 Flexible Ratchet Handles	Standard	2774 series	61	3774 series	93-94	4774 series	121-122				
	Short	2774PS 2774JS	60 60	3774PS	92						
	Long					4774P-450	121				
	Compact			2774-3/8 series	92						
	Swivel Head			3776 series	94						
	Speeder			3774P-SR	94						
 Hinge Handles	Standard	2768 series	62	3768-250 series	97	4768-380 series	122	6768	133	8768	138
	Long					4768-450 series	122	6768-600	133	8768-1000	138
	Extra Long			3768P-380	97	4768-600 series	122	6768-1000	133		
 T-type Slide Handles	Standard	2785	64	3785	98	4785	124	6785	134	8785	138
	Long									8785-700	138
 Spin Type Handles	Standard	2769N	63	3769N	97						
	Wobble-Fix	2769NWF	63	3769NWF	97						
	Others	2769H	63	3769H	97						
 L-handles						4788 4747	125 125	6788	134	8788	138
 Speed Handles	Standard	2780	64	3780	98	4780-400	124				
	Flexible					4781N-450	124				
 Extension Bars	Standard	2760	62	3760	96	4760	123	6760	133	8760	137
	Wobble-Fix	2763	62	3763 3763L	96 96	4763	123				
	Flexible	2762	61	3762	95						
 Universal Joints		2770 2771	64 64	3770 3771	98 98	4770 4771	124 124	6770	134	8770	137
 Adaptors		2233A	64	3322A 3344A	98 98	4433A 4466A	125 125	6644A 6688A	134 134	8866A	137
 Ratchet Adaptors		2755	61	3755	95	4755	122	6755	133		
 Quick Spinners		2756	61	3756	95	4756	122				

Hand Sockets  
Hand Steckschlüssel  
Douilles à main

# 1/4"

Z-SERIES

HAND

TITANIUM

SCREWDRIVERS ACCESSORIES

IMPACT

SLEEVE-DRIVE

PROTECTOR

INDUSTRIAL

AUTOMOTIVE

MOTORCYCLE

CONSTRUCTION

SPARE PART

## 2400M / 2400A

6-point Sockets  
6-kant Steckschlüssel  
Douilles 6-pans

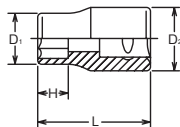

2400M 2405M (mm)	D <sub>1</sub> (mm)	D <sub>2</sub> (mm)	H (mm)	L (mm)	(g)	(pcs.)
3	5.5	11.2	2.6	22	7	10
3.5	6.1	11.2	3	22	7	10
4	6.7	11.2	3.5	22	8	10
4.5	7.3	11.2	4	22	8	10
5	8	11.2	5	22	8	10
5.5	8.5	11.2	5.5	22	9	10
6	9.2	11.2	5.5	22	9	10
7	10.3	11.2	6	22	9	10
8	11.2	11.7	6.9	22	11	10
9	13	12	7.3	22	12	10
10	14.3	12.9	7.7	22	15	10
11	15.5	14.3	9.3	22	18	10
12	16.8	15.5	9.3	22	23	10
13	18	16.4	9.8	22	23	10
14	19.3	17.9	11	24	30	10

## 2405M / 2405A

12-point Sockets  
12-kant Steckschlüssel  
Douilles 12-pans

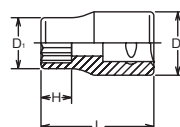

2400A 2405A (inch)	D <sub>1</sub> (mm)	D <sub>2</sub> (mm)	H (mm)	L (mm)	(g)	(pcs.)
1/8	5.7	11.2	2.7	22	7	10
5/32	6.7	11.2	3.5	22	8	10
3/16	7.8	11.2	5	22	8	10
7/32	8.5	11.2	5.5	22	9	10
1/4	9.6	11.2	5.8	22	9	10
9/32	10.3	11.2	6	22	9	10
5/16	11.2	11.7	6.9	22	11	10
11/32	12.5	11.7	7.3	22	12	10
3/8	13.7	12.5	7.7	22	15	10
7/16	15.5	14.3	9.3	22	18	10
1/2	18	16.4	9.8	22	23	10
9/16	19.3	17.9	11	24	30	10

## RS2400M/12 RS2405M/12

Socket Set on Rail  
Steckschlüsselsatz auf Schiene  
Jeu de douilles sur rail



RS2400M/12	12 Pieces Set/Rail 200mm	(g)
4, 5, 5.5, 6, 7, 8, 9, 10, 11, 12, 13, 14		200

RS2405M/12	12 Pieces Set/Rail 200mm	(g)
4, 5, 5.5, 6, 7, 8, 9, 10, 11, 12, 13, 14		200

## RS2400A/9 RS2405A/9

Socket Set on Rail  
Steckschlüsselsatz auf Schiene  
Jeu de douilles sur rail



RS2400A/9	9 Pieces Set/Rail 150mm	(g)
3/16, 7/32, 1/4, 9/32, 5/16, 11/32, 3/8, 7/16, 1/2		162

RS2405A/9	9 Pieces Set/Rail 150mm	(g)
3/16, 7/32, 1/4, 9/32, 5/16, 11/32, 3/8, 7/16, 1/2		162

## AS2405A

12-point Sockets, AS954  
12-kant Steckschlüssel, AS954  
Douilles 12-pans, AS954

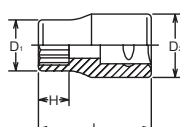

AS2405A (inch)	D <sub>1</sub> (mm)	D <sub>2</sub> (mm)	H (mm)	L (mm)	(g)	(pcs.)
3/16	7.7	10.9	5.1	22	8	10
7/32	8.5	10.9	5.5	22	8	10
1/4	9.4	10.9	5.9	22	8	10
9/32	10.2	10.9	6.1	22	8	10
5/16	11.3	11.7	7.3	22	10	10
11/32	12.5	12	7.5	22	10	10
3/8	13.7	12.9	8.2	22	13	10
7/16	15.6	14.3	9.4	22	17	10
1/2	17.2	16.4	10.3	22	20	10
9/16	18.8	17.9	11	24	27	10

Aerospace Standard SAE AS954

## RSAS2405A/10

Socket Set on Rail  
Steckschlüsselsatz auf Schiene  
Jeu de douilles sur rail



RSAS2405A/10	10 Pieces Set/Rail 150mm	(g)
3/16, 7/32, 1/4, 9/32, 5/16, 11/32, 3/8, 7/16, 1/2, 9/16		160

# 1/4" Hand Sockets Hand Steckschlüssel Douilles à main

2410M (mm)	D <sub>1</sub> (mm)	D <sub>2</sub> (mm)	H (mm)	L (mm)	(g)	(pcs.)
4	6.7	11.2	3.5	22	8	10
4.5	7.3	11.2	4	22	8	10
5	8	11.2	5	22	8	10
5.5	8.5	11.2	5.5	22	9	10
6	9.2	11.2	5.5	22	9	10
7	10.3	11.2	6	22	9	10
8	11.2	11.7	6.9	22	11	10
9	13	12	7.3	22	12	10
10	14.3	12.9	7.7	22	15	10
11	15.5	14.3	9.3	22	18	10
12	16.8	15.5	9.3	22	23	10
13	18	16.4	9.8	22	23	10
14	19.3	17.9	11	24	30	10



**2410M** Surface Drive Sockets  
Surface Drive Steckschlüssel  
Douilles, Surface Drive

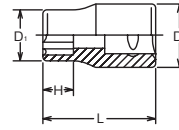

RS2410M/12	12 Pieces Set/Rail 200mm	(g)
4, 5, 5.5, 6, 7, 8, 9, 10, 11, 12, 13, 14		222

**RS2410M/12** Socket Set on Rail  
Steckschlüsselsatz auf Schiene  
Jeu de douilles sur rail



2400W (BA)	D <sub>1</sub> (mm)	D <sub>2</sub> (mm)	H (mm)	L (mm)	(g)	(pcs.)
8	6.1	11.2	3	22	7	10
7	7.3	11.2	4	22	8	10
6	8	11.2	5	22	8	10
5	8.5	11.2	5.5	22	9	10
4	9.6	11.2	5.8	22	9	10
3	10.3	11.2	6	22	9	10
2	11.2	11.7	6.9	22	11	10
1	13	12	7.3	22	12	10
0	14.9	13.6	8	22	16	10

**2400W-BA** 6-point Sockets  
6-kant Steckschlüssel  
Douilles 6-pans

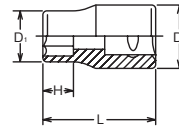

RS2400W/9-BA	9 Pieces Set/Rail 150mm	(g)
8, 7, 6, 5, 4, 3, 2, 1, 0		120

**RS2400W/9-BA** Socket Set on Rail  
Steckschlüsselsatz auf Schiene  
Jeu de douilles sur rail



**BA**



BA	8BA	7BA	6BA	5BA	4BA	3BA	2BA	1BA	0BA	
S	(ref. mm)	3.86	4.37	4.90	5.59	6.30	7.16	8.23	9.27	10.49
	(ref. inch)	0.152	0.172	0.193	0.220	0.248	0.282	0.324	0.365	0.413

2415M (mm)	D <sub>1</sub> (mm)	D <sub>2</sub> (mm)	H (mm)	L (mm)	(g)	(pcs.)
5.5	10.3	11.2	5.4	22	10	10
6	11	11.7	5.4	22	13	10
7	12.5	11.7	6.1	22	13	10
8	14.3	12.9	6.8	22	17	10
10	17.4	16	8.2	22	27	10

**2415M / 2415A** Double 4-point Sockets  
Doppelvierkant Steckschlüssel  
Douilles mâles 4-pans doubles

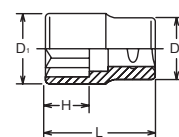

2415A (inch)	D <sub>1</sub> (mm)	D <sub>2</sub> (mm)	H (mm)	L (mm)	(g)	(pcs.)
1/4	11	11.7	5.4	22	14	10
5/16	14.3	12.9	6.8	22	17	10
11/32	15.9	14.3	7.5	22	21	10
3/8	17.4	16	8.2	22	26	10

Z-SERIES  
HAND  
TITANIUM  
ACCESSORIES  
SCREWDRIVERS  
IMPACT  
SLEEVE-DRIVE  
PROTECTOR  
INDUSTRIAL  
AUTOMOTIVE  
MOTORCYCLE  
CONSTRUCTION  
SPARE PART

# Hand Sockets Hand Steckschlüssel Douilles à main

# 1/4"

Z-SERIES  
HAND  
TITANIUM  
SCREWDRIVERS ACCESSORIES  
IMPACT  
SLEEVE-DRIVE  
PROTECTOR  
INDUSTRIAL  
AUTOMOTIVE  
MOTORCYCLE  
CONSTRUCTION  
SPARE PART

## 2450MS / 2450AS

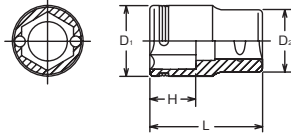

 Nut Grip Sockets **Nut Grip®**  
Steckschlüssel mit 2-facher Kugelhalterung  
Douilles à billes de retenue



2450MS (mm)	D <sub>1</sub> (mm)	D <sub>2</sub> (mm)	H (mm)	L (mm)	(g)	(pcs.)
5	9.2	11.2	3.5	17	6	10
5.5	9.8	11.2	3.5	17	7	10
6	10.2	11.2	3.5	17	8	10
7	11.5	11.2	4	18	8	10
8	12.3	11.7	5	18	9	10
9	13.3	12	5.5	19	12	10
10	14.3	12.9	6	19	13	10
11	15.8	14.3	6.5	20	15	10
12	16.8	16	7	20	22	10
13	18	17	8	21	22	10
14	20	18	8.5	22	31	10

2450AS (inch)	D <sub>1</sub> (mm)	D <sub>2</sub> (mm)	H (mm)	L (mm)	(g)	(pcs.)
1/4	10.7	11.2	3.5	17	8	10
5/16	12.3	11.7	5	18	9	10
3/8	14.3	12.9	6	19	14	10
7/16	16	14.3	6.5	20	17	10
1/2	18	16.4	8	21	23	10
9/16	20	18	8.5	22	31	10

## RS2450MS/6 RS2450MS/11



  Socket Set on Rail  
Steckschlüsselsatz auf Schiene  
Jeu de douilles sur rail



RS2450MS/6	6 Pieces Set/Rail 150mm	(g)
<b>7, 8, 10, 12, 13, 14</b>		120

RS2450MS/11	11 Pieces Set/Rail 200mm	(g)
<b>5, 5.5, 6, 7, 8, 9, 10, 11, 12, 13, 14</b>		194

## RS2450AS/6

  Socket Set on Rail  
Steckschlüsselsatz auf Schiene  
Jeu de douilles sur rail



RS2450AS/6	6 Pieces Set/Rail 150mm	(g)
<b>1/4, 5/16, 3/8, 7/16, 1/2, 9/16</b>		120

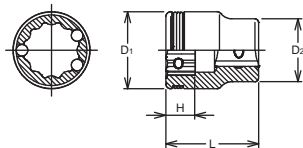

## 2455AS

 12-point **Nut Grip®** Sockets with 3 Ball retaining  
12-kant Steckschlüsseleinsätze mit 3fach Kugelsicherung  
Douilles pour écrous à 12 points avec 3 retenues de billes



2455AS (inch)	D <sub>1</sub> (mm)	D <sub>2</sub> (mm)	H (mm)	L (mm)	(g)	(pcs.)
7/32	10.2	11.2	3.5	17	8	10
1/4	11.8	11.2	3.5	17	9	10
9/32	12.5	11.2	4	17	10	10
5/16	13.5	11.7	5	18	12	10
11/32	14.1	12	5.5	19	14	10
3/8	15.4	12.9	6	19	16	10
7/16	17	15	6.5	20	21	10
1/2	18.9	17	8	21	26	10
9/16	20.7	18.7	8.5	22.5	34	10

## RS2455AS/6

  Socket Set on Rail  
Steckschlüsselsatz auf Schiene  
Jeu de douilles sur rail



RS2455AS/6	6 Pieces Set/Rail 150mm	(g)
<b>1/4, 5/16, 3/8, 7/16, 1/2, 9/16</b>		138

2425 (E)	D <sub>1</sub> (mm)	D <sub>2</sub> (mm)	H (mm)	L (mm)	(g)	(pcs.)
E 4	5.4	11.2	4.6	22	7	10
E 5	6.7	11.2	5.2	22	8	10
E 6	7.7	11.2	5.4	22	8	10
E 7	8.3	11.2	6.6	22	9	10
E 8	9.6	11.2	7	22	9	10
E10	11.3	12	8.2	22	10	10
E11	12.9	12	8.7	22	13	10
E12	14.3	12.9	9.3	23	17	10

RS2425/6	6 Pieces Set/Rail 150mm	(g)
E4, E5, E6, E7, E8, E10		85

## 2425 TORX® Sockets TORX® Steckschlüssel Douilles TORX®

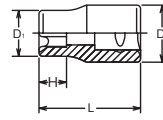

## RS2425/6 Socket Set on Rail Steckschlüsselsatz auf Schiene Jeu de douilles sur rail



### TORX® (E)

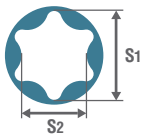

E	E4	E5	E6	E7	E8	E10	E11	E12	E14	E16	E18	E20	E22	E24	E26	E28	E30	E32
S <sub>1</sub> (ref. mm)	3.7	4.6	5.6	6.1	7.4	9.3	9.9	11.0	12.8	14.6	16.5	18.3	20.1	22.0	23.7	25.5	27.3	29.0
S <sub>2</sub> (ref. mm)	2.7	3.3	4.0	4.3	5.3	6.8	7.1	7.9	9.2	10.5	11.9	13.2	14.8	15.7	17.5	18.3	20.0	21.3

2300X (mm)	D <sub>1</sub> (mm)	D <sub>2</sub> (mm)	H <sub>1</sub> (mm)	H <sub>2</sub> (mm)	L (mm)	(g)	(pcs.)
4	6.7	11.2	4	22	32	10	10
5	8	11.2	5.5	22	32	11	10
5.5	8.5	11.2	6	22	32	12	10
6	9.2	11.2	7	22	32	12	10
7	10.5	11.2	8	22	32	13	10
8	11.8	11.2	9	22	32	16	10
9	13	12	10	22	32	18	10
10	14.3	12.9	11	21	32	23	10
11	15.5	14.3	12	21	32	27	10
12	16.8	15.5	13	21	32	29	10
13	18	16.4	14	21	32	32	10
14	19.3	17.9	16	20	32	37	10

RS2300X/12	12 Pieces Set/Rail 200mm	(g)
4, 5, 5.5, 6, 7, 8, 9, 10, 11, 12, 13, 14		270

## 2300X 6-point Sockets, Semi-Deep 6-kant Steckschlüssel, mittel-lang Douilles, semi-profondes 6-pan

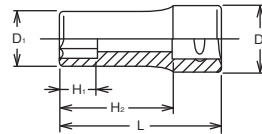

## RS2300X/12 Socket Set on Rail Steckschlüsselsatz auf Schiene Jeu de douilles sur rail



2350X (mm)	D <sub>1</sub> (mm)	D <sub>2</sub> (mm)	H <sub>1</sub> (mm)	H <sub>2</sub> (mm)	L (mm)	(g)	(pcs.)
8	12.3	11.7	5	21.5	32	17	10
10	14.3	12.9	6	21.5	32	22	10
12	16.8	16	7	21.5	32	34	10
13	18	17	8	21.5	32	40	10
14	20	18	8.5	21.5	32	43	10



NUT GRIP®

## 2350X Nut Grip Socket, Semi-Deep Nut Grip® Steckschlüssel mit 2-facher Kugelhalterung, mittel-lang Douilles à billes de retenue, semi-profondes

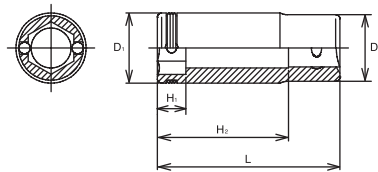

## RS2350X/4 Socket Set on Rail Steckschlüsselsatz auf Schiene Jeu de douilles sur rail



Hand Sockets  
Hand Steckschlüssel  
Douilles à main

# 1/4"

Z-SERIES

HAND

TITANIUM

SCREWDRIVERS ACCESSORIES

IMPACT

SLEEVE-DRIVE

PROTECTOR

INDUSTRIAL

AUTOMOTIVE

MOTORCYCLE

CONSTRUCTION

SPARE PART

## 2300M / 2300A

6-point Deep Sockets  
6-kant-Steckschlüssel, lang  
Douilles longues 6-pans

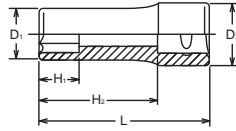

2300M 2305M (mm)	D <sub>1</sub> (mm)	D <sub>2</sub> (mm)	H <sub>1</sub> (mm)	H <sub>2</sub> (mm)	L (mm)	(g)	(pcs.)
3	5.5	11.2	3	40	50	15	10
4	6.7	11.2	4	40	50	15	10
4.5	7.3	11.2	4.5	40	50	15	10
5	8	11.2	5.5	40	50	17	10
5.5	8.5	11.2	6	40	50	17	10
6	9.2	11.2	7	40	50	20	10
7	10.5	11.2	8	40	50	25	10
8	11.8	11.2	9	40	50	25	10
9	13	12	10	40	50	30	10
10	14.3	12.9	11	39	50	34	10
11	15.5	14.3	12	39	50	43	10
12	16.8	15.5	13	39	50	50	10
13	18	16.4	14	39	50	52	10
14	19.3	17.9	16	38	50	57	10

## 2305M / 2305A

12-point Deep Sockets  
12-kant Steckschlüssel, lang  
Douilles longues, 12-pans

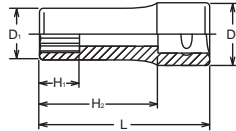

2300A 2305A (inch)	D <sub>1</sub> (mm)	D <sub>2</sub> (mm)	H <sub>1</sub> (mm)	H <sub>2</sub> (mm)	L (mm)	(g)	(pcs.)
1/8	5.7	11.2	3.5	40	50	15	10
5/32	6.7	11.2	4	40	50	15	10
3/16	7.8	11.2	5.5	40	50	17	10
7/32	8.5	11.2	6	40	50	17	10
1/4	9.8	11.2	7	40	50	25	10
9/32	10.5	11.2	8	40	50	25	10
5/16	11.8	11.2	9	40	50	25	10
11/32	12.5	11.7	10	40	50	30	10
3/8	13.7	12.5	11	40	50	34	10
7/16	15.5	14.3	12	39	50	43	10
1/2	18	16.4	14	39	50	52	10
9/16	19.3	17.9	16	38	50	57	10

## RS2300M/12

Socket Set on Rail  
Steckschlüsselsatz auf Schiene  
Jeu de douilles sur rail



RS2300M/12	12 Pieces Set/Rail 200mm	(g)
4, 5, 5.5, 6, 7, 8, 9, 10, 11, 12, 13, 14		400

RS2305M/12	12 Pieces Set/Rail 200mm	(g)
4, 5, 5.5, 6, 7, 8, 9, 10, 11, 12, 13, 14		400

## RS2300A/9

Socket Set on Rail  
Steckschlüsselsatz auf Schiene  
Jeu de douilles sur rail



RS2300A/9	9 Pieces Set/Rail 150mm	(g)
3/16, 7/32, 1/4, 9/32, 5/16, 11/32, 3/8, 7/16, 1/2		296

RS2305A/9	9 Pieces Set/Rail 150mm	(g)
3/16, 7/32, 1/4, 9/32, 5/16, 11/32, 3/8, 7/16, 1/2		296

## AS2305A

12-point Deep Sockets, AS954  
12-kant Steckschlüssel, lang, AS954  
Douilles longues 12-pans, AS954

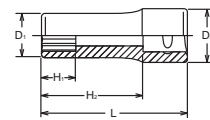

AS2305A (inch)	D <sub>1</sub> (mm)	D <sub>2</sub> (mm)	H <sub>1</sub> (mm)	H <sub>2</sub> (mm)	L (mm)	(g)	(pcs.)
3/16	7.7	10.9	6	40	50	17	10
7/32	8.5	10.9	6.5	40	50	17	10
1/4	9.4	10.9	7	40	50	19	10
9/32	10.2	10.9	8	40	50	18	10
5/16	11.3	11.7	9	40	50	23	10
11/32	12.5	12	10	40	50	24	10
3/8	13.7	12.8	11	39	50	31	10
7/16	15.6	14.2	12	39	50	38	10
1/2	17.2	16.2	14	39	50	42	10
9/16	18.8	17.1	16	38	50	47	10

Aerospace Standard SAE AS954

## RSAS2305A/10

Socket Set on Rail  
Steckschlüsselsatz auf Schiene  
Jeu de douilles sur rail



RSAS2305A/10	10 Pieces set/Rail 150mm	(g)
3/16, 7/32, 1/4, 9/32, 5/16, 11/32, 3/8, 7/16, 1/2, 9/16		307

2310M (mm)	D <sub>1</sub> (mm)	D <sub>2</sub> (mm)	H <sub>1</sub> (mm)	H <sub>2</sub> (mm)	L (mm)	(g)	(pcs.)
3	5.5	11.2	3	40	50	15	10
4	6.7	11.2	4	40	50	15	10
4.5	7.3	11.2	4.5	40	50	15	10
5	8	11.2	5.5	40	50	17	10
5.5	8.5	11.2	6	40	50	17	10
6	9.2	11.2	7	40	50	20	10
7	10.5	11.2	8	40	50	25	10
8	11.8	11.2	9	40	50	25	10
9	13	12	10	40	50	30	10
10	14.3	12.9	11	39	50	34	10
11	15.5	14.3	12	39	50	43	10
12	16.8	15.5	13	39	50	50	10
13	18	16.4	14	39	50	52	10
14	19.3	17.9	16	38	50	57	10



**2310M** Surface Drive Deep Sockets  
Surface Drive Steckschlüssel, lang  
Douilles longues, Surface Drive

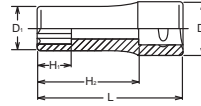

RS2310M/12	12 Pieces set/Rail 200mm	(g)
4, 5, 5.5, 6, 7, 8, 9, 10, 11, 12, 13, 14		400

**RS2310M/12** Socket Set on Rail  
Steckschlüsselsatz auf Schiene  
Jeu de douilles sur rail



2300W (BA)	D <sub>1</sub> (mm)	D <sub>2</sub> (mm)	H <sub>1</sub> (mm)	H <sub>2</sub> (mm)	L (mm)	(g)	(pcs.)
4	9.8	11.2	7	40	50	22	10
3	10.5	11.2	8	40	50	25	10
2	11.8	11.2	9	40	50	25	10
1	13	12	10	40	50	30	10
0	14.9	13.6	12	39	50	38	10

**2300W-BA** 6-point Deep Sockets  
6-kant-Steckschlüssel, lang  
Douilles longues 6-pans

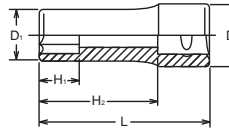

**BA**



	BA	8BA	7BA	6BA	5BA	4BA	3BA	2BA	1BA	0BA
S	(ref. mm)	3.86	4.37	4.90	5.59	6.30	7.16	8.23	9.27	10.49
	(ref. inch)	0.152	0.172	0.193	0.220	0.248	0.282	0.324	0.365	0.413

2325 (E)	D <sub>1</sub> (mm)	D <sub>2</sub> (mm)	H <sub>1</sub> (mm)	H <sub>2</sub> (mm)	L (mm)	(g)	(pcs.)
E 4	5.4	12	4.6	40	50	17	10
E 5	6.8	12	5.2	40	50	20	10
E 6	8	12	5.4	40	50	20	10
E 7	8.3	12	6.6	40	50	22	10
E 8	9.8	12	7	40	50	25	10
E10	11.6	12	8.2	40	50	29	10

**2325** TORX® Deep Sockets  
TORX® Steckschlüssel, lang  
Douilles longues TORX®

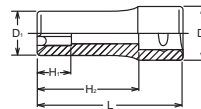

**TORX® (E)**

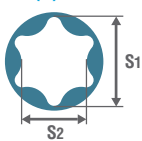

	E	E4	E5	E6	E7	E8	E10	E11	E12	E14	E16	E18	E20	E22	E24	E26	E28	E30	E32
S <sub>1</sub>	(ref. mm)	3.7	4.6	5.6	6.1	7.4	9.3	9.9	11.0	12.8	14.6	16.5	18.3	20.1	22.0	23.7	25.5	27.3	29.0
S <sub>2</sub>	(ref. mm)	2.7	3.3	4.0	4.3	5.3	6.8	7.1	7.9	9.2	10.5	11.9	13.2	14.8	15.7	17.5	18.3	20.0	21.3

2350M (mm)	D <sub>1</sub> (mm)	D <sub>2</sub> (mm)	H <sub>1</sub> (mm)	H <sub>2</sub> (mm)	L (mm)	(g)	(pcs.)
8	12.3	11.7	5	39.5	50	30	10
10	14.3	12.9	6	39.5	50	35	10
12	16.8	16	7	39.5	50	55	10
13	18	17	8	39.5	50	65	10
14	20	18	8.5	39.5	50	70	10



**2350M** Nut Grip Deep Sockets **Nut Grip®**  
Steckschlüssel mit 2-facher Kugelhalterung, lang  
Douilles longues à billes de retenue

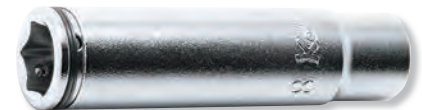
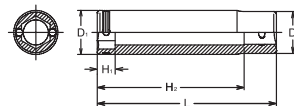

RS2350M/4	4 Pieces Set/Rail 150mm	(g)
8, 10, 12, 14		220

**RS2350M/4** Socket Set on Rail  
Steckschlüsselsatz auf Schiene  
Jeu de douilles sur rail



# Hand Sockets Hand Steckschlüssel 1/4" Douilles à main

Z-SERIES  
HAND  
TITANIUM  
SCREWDRIVERS ACCESSORIES  
IMPACT  
SLEEVE-DRIVE  
PROTECTOR  
INDUSTRIAL  
AUTOMOTIVE  
MOTORCYCLE  
CONSTRUCTION  
SPARE PART

## 2440M / 2440A

6-point Universal Sockets  
6-kant Gelenk-Einsätze  
Douilles articulées, 6-pans

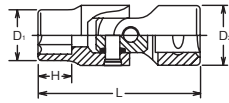

## 2445M / 2445A

12-point Universal Sockets  
12-kant Gelenk-Einsätze  
Douilles articulées, 12-pans

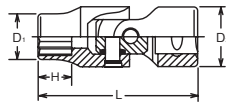

## RS2445A/9

Socket Set on Rail  
Steckschlüsselsatz auf Schiene  
Jeu de douilles sur rail



## AS2445A

12-point Universal Sockets  
12-kant Gelenk-Einsätze  
Douilles articulées, 12-pans

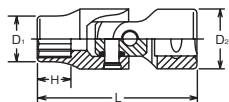

## 2440T

TORX® Universal Sockets  
TORX® Gelenk-Einsätze  
Douilles articulées TORX®

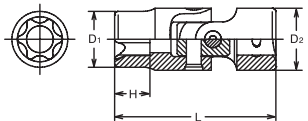

## 2441M

Nut Grip Universal Sockets **Nut Grip®**  
Gelenk-Einsätze mit zweifacher Kugelhalterung  
Douilles articulées à billes de retenue

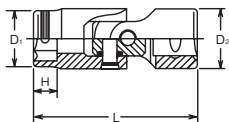

## RS2441M/11

Socket Set on Rail  
Steckschlüsselsatz auf Schiene  
Jeu de douilles sur rail



2440M 2445M (mm)	D <sub>1</sub> (mm)	D <sub>2</sub> (mm)	H (mm)	L (mm)	(g)	(pcs.)
4	6.7	13	4.8	31.5	17	10
5	8	13	5.3	32	17	10
6	9.2	13	6.1	33	18	10
7	10.5	13	6.5	33	19	10
8	11.7	13	7	34	19	10
9	13	13	7	34	20	10
10	14.2	13	8.3	35	20	10
11	15.5	13	9.5	36	21	10
12	16.7	13	10	37	21	10
13	18	13	10.5	37	26	10
14	19.2	13	10.5	37	28	10

2440A (inch)	D <sub>1</sub> (mm)	D <sub>2</sub> (mm)	H (mm)	L (mm)	(g)	(pcs.)
1/4	9.8	13	6.5	33	18	10
5/16	11.7	13	7	34	19	10
3/8	13.7	13	8.3	35	20	10
7/16	15.5	13	9.5	36	21	10
1/2	18	13	10.5	37	26	10
9/16	19.2	13	10.5	37	28	10

2445A (inch)	D <sub>1</sub> (mm)	D <sub>2</sub> (mm)	H (mm)	L (mm)	(g)	(pcs.)
3/16	8	13	5.3	32	18	10
1/4	9.8	13	6.5	33	18	10
9/32	10.5	13	6.5	33	19	10
5/16	11.7	13	7	34	19	10
11/32	13	13	7	34	20	10
3/8	13.7	13	8.3	35	20	10
7/16	15.5	13	9.5	36	21	10
1/2	18	13	10.5	37	26	10
9/16	19.2	13	10.5	37	28	10

RS2445A/9	9 Pieces set/Rail 150mm	(g)
3/16, 1/4, 9/32, 5/16, 11/32, 3/8, 7/16, 1/2, 9/16		220

AS2445A (inch)	D <sub>1</sub> (mm)	D <sub>2</sub> (mm)	H (mm)	L (mm)	(g)	(pcs.)
1/4	9.6	12.9	5.7	31.8	18	10
5/16	11.7	12.9	7	34.6	21	10
3/8	13.5	12.9	8.3	35.1	21	10
7/16	15.5	12.9	9.5	39.1	25	10
1/2	17.2	12.9	10.5	40.1	27	10

2440T (E)	D <sub>1</sub> (mm)	D <sub>2</sub> (mm)	H (mm)	L (mm)	(g)	(pcs.)
E 6	8	13	5.4	31.9	20	10
E 8	9.8	13	7	33.1	20	10
E10	11.7	13	8.2	33.6	21	10
E12	14.2	13	9.3	35.1	24	10

2441M (mm)	D <sub>1</sub> (mm)	D <sub>2</sub> (mm)	H (mm)	L (mm)	(g)	(pcs.)
5	9.2	13	3.5	31.5	20	10
5.5	9.8	13	3.5	31.5	20	10
6	10.2	13	3.5	31.5	19	10
7	11.3	13	4	31.5	20	10
8	12.3	13	5	32	20	10
10	14.5	13	6	32.5	21	10
11	15.5	13	6.5	33.5	21	10
12	16.8	13	7	34	24	10
13	18	13	8	35	25	10
14	20	13	8.5	35.5	30	10
15	21	13	9	36	32	10

RS2441M/11	11 Pieces Set/Rail 200mm	(g)
5, 5.5, 6, 7, 8, 10, 11, 12, 13, 14, 15		280

2430M (mm)	D (mm)	H (mm)	L (mm)	(g)	(pcs.)
3	13	5.5	40	18	10
4	13	5.5	40	18	10
5	13	6.5	40	20	10
6	13	7.5	40	21	10

## 2430M Universal Hex Sockets Gelenk-Einsätze für Schrauben mit Innensechskant Douilles articulées, 6-pans mâles

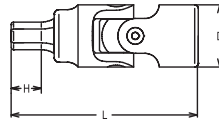

2430T (T)	D (mm)	L (mm)	(g)	(pcs.)
T 8	13	42	22	10
T 9	13	42	22	10
T10	13	42	22	10
T15	13	42	22	10
T20	13	42	22	10
T25	13	42	22	10
T27	13	42	22	10
T30	13	42	22	10

## 2430T TORX® Universal Sockets TORX® Gelenk-Einsätze Douilles articulées TORX®

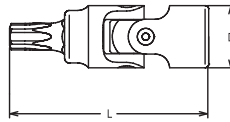

2000-28 (PH)	D (mm)	H (mm)	L (mm)	(g)	(pcs.)
1	11.9	12	28	10	10
2	11.9	12	28	11	10
3	11.9	12	28	12	10
4	13.1	11	28	14	10

## 2000-28 (PH) PH Bit Sockets Steckschlüssel für Kreuzschlitzschrauben, PH Douilles tournevis pour vis à empreinte PH

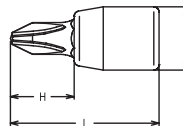

2000-28 (PZ)	D (mm)	H (mm)	L (mm)	(g)	(pcs.)
PZ1	11.9	12	28	10	10
PZ2	11.9	12	28	11	10
PZ3	11.9	12	28	12	10

## 2000-28 (PZ) PZ Bit Sockets Steckschlüssel für Kreuzschlitzschrauben, PZ Douilles tournevis pour vis à empreinte PZ

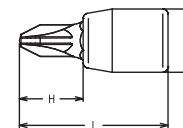

2005-25	TxW (mm)	D (mm)	H (mm)	L (mm)	(g)	(pcs.)
3	0.5x 3	11.9	9	25	9	10
4	0.8x 4	11.9	9	25	10	10
5	1.0x 5.5	11.9	9	25	10	10
6	1.2x 6.5	13.1	9	25	11	10
8	1.2x 8	13.1	9	25	12	10
9	1.6x 8	13.1	9	25	12	10
10	1.6x10	14.3	9	25	13	10

## 2005-25 Bit Sockets for Slotted Head Steckschlüssel für Schlitzschrauben Douilles tournevis pour vis à fente

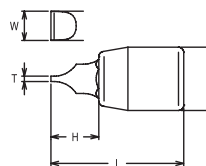

Z-SERIES  
HAND  
TITANIUM  
SCREWDRIVERS ACCESSORIES  
IMPACT  
SLEEVE-DRIVE  
PROTECTOR  
INDUSTRIAL  
AUTOMOTIVE  
MOTORCYCLE  
CONSTRUCTION  
SPARE PART

## 2010M-25 / -50 / -100 2010A-25 / -100

 Inhex Bit Sockets  
Steckschlüssel für Innensechskant-Schrauben  
Douilles tournevis pour vis 6-pans creux

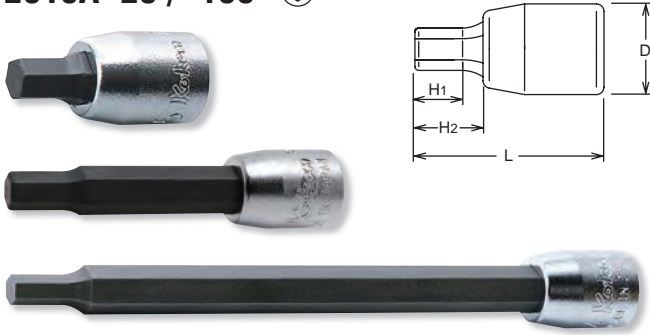

2010A-25 (inch)	D (mm)	H <sub>1</sub> (mm)	H <sub>2</sub> (mm)	L (mm)	(g)	(pcs.)
1/8	11.9	5	9	25	9	10
5/32	11.9	5.6	9	25	9	10
3/16	11.9	6.1	9	25	10	10
7/32	11.9	6.8	9	25	11	10
1/4	11.9	-	9	25	12	10
9/32	13.1	7.2	8	25	12	10
5/16	13.1	-	8	25	14	10
3/8	14.3	7.2	8	25	17	10
7/16	18.1	7.2	8	25	35	10

2010A-100 (inch)	D (mm)	H <sub>1</sub> (mm)	H <sub>2</sub> (mm)	L (mm)	(g)	(pcs.)
1/8	11.9	8.5	84	100	29	10
5/32	11.9	8.5	84	100	30	10
3/16	13.1	8.5	83	100	45	10
7/32	13.1	8.5	83	100	46	10
1/4	13.1	8.5	83	100	46	10
9/32	13.1	8.5	83	100	47	10
5/16	13.1	-	83	100	49	10
3/8	14.3	8.5	83	100	75	10

2010M-25 (mm)	D (mm)	H <sub>1</sub> (mm)	H <sub>2</sub> (mm)	L (mm)	(g)	(pcs.)
1.5	11.9	2.5	9	25	9	10
2	11.9	3.5	9	25	9	10
2.5	11.9	4.5	9	25	9	10
3	11.9	5	9	25	9	10
4	11.9	5.6	9	25	9	10
5	11.9	6.3	9	25	10	10
6	11.9	7.6	9	25	12	10
7	13.1	7.2	8	25	12	10
8	13.1	-	8	25	14	10
10	14.3	-	8	25	17	10
12	16.4	-	8	25	36	10

2010M-50 (mm)	D (mm)	H <sub>1</sub> (mm)	H <sub>2</sub> (mm)	L (mm)	(g)	(pcs.)
New 2	11.9	4	34	50	16	10
New 2.5	11.9	5	34	50	16	10
New 3	11.9	8.5	34	50	16	10
New 4	11.9	8.5	34	50	17	10
New 5	11.9	8.5	34	50	18	10
New 6	11.9	8.5	34	50	18	10

2010M-100 (mm)	D (mm)	H <sub>1</sub> (mm)	H <sub>2</sub> (mm)	L (mm)	(g)	(pcs.)
2	11.9	4	84	100	30	10
2.5	11.9	5	84	100	30	10
3	11.9	8.5	84	100	30	10
4	11.9	8.5	84	100	30	10
5	13.1	8.5	83	100	30	10
6	13.1	8.5	83	100	35	10
7	13.1	8.5	83	100	35	10
8	13.1	-	83	100	38	10
10	14.3	-	83	100	45	10
12	16.4	-	83	100	107	10

## RS2010M/7-L25 RS2010A/8-L25

 Socket Set on Rail  
Steckschlüsselsatz auf Schiene  
Jeu de douilles sur rail



RS2010M/7-L25	7 Pieces set/Rail 150mm	(g)
3, 4, 5, 6, 7, 8, 10		115

RS2010A/8-L25	8 Pieces set/Rail 150mm	(g)
1/8, 5/32, 3/16, 7/32, 1/4, 9/32, 5/16, 3/8		130

## RS2010M/6-L50

 Socket Set on Rail  
Steckschlüsselsatz auf Schiene  
Jeu de douilles sur rail



RS2010M/6-L50	6 Pieces set/Rail 150mm	(g)
2, 2.5, 3, 4, 5, 6		125

## 2011M-50

 Ballpoint Inhex Sockets  
Steckschlüssel mit Kugelkopf, für Innensechskant-Schrauben  
Douilles tournevis avec tête sphérique pour vis 6-pans creux



2011M-50 (mm)	D (mm)	H (mm)	L (mm)	(g)	(pcs.)
3	11.9	34	50	16	10
4	11.9	34	50	17	10
5	11.9	34	50	18	10
6	11.9	34	50	18	10

 Ball point bit sockets have less strength due to the special design. Make sure to use them correctly.

Kugelkopf-Biteinsätze haben aufgrund der speziellen Form eine geringere Festigkeit. Achten Sie darauf, sie richtig zu verwenden.

Les douilles pour embouts à tête sphérique sont moins résistantes en raison de leur conception spéciale. Veuillez les utiliser correctement.

2020-28 (XZN)	D (mm)	H (mm)	L (mm)	(g)	(pcs.)
M4	11.9	12	28	12	10
M5	11.9	12	28	12	10
M6	11.9	12	28	13	10
M8	13.1	11	28	14	10

2020-50 (XZN)	D (mm)	H (mm)	L (mm)	(g)	(pcs.)
M4	11.9	34	50	20	10
M5	11.9	34	50	20	10
M6	11.9	34	50	22	10
M8	13.1	33	50	24	10

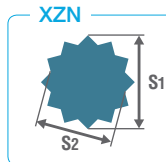

XZN		M4	M5	M6	M8	M10	M12	M14	M16	M18
S1	(ref. mm)	3.6	4.8	6.1	7.3	9.7	11.5	13.3	15.7	16.9
S2	(ref. mm)	3.1	4.1	5.1	6.1	8.1	9.7	11.2	13.2	14.2

## 2020-28 / -50 XZN Bit Sockets

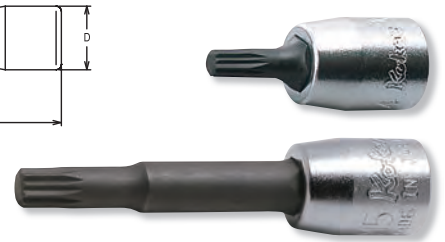
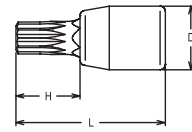

2025-28 (T)	D (mm)	H (mm)	L (mm)	(g)	(pcs.)
T 8	11.9	12	28	10	10
T 9	11.9	12	28	10	10
T10	11.9	12	28	10	10
T15	11.9	12	28	10	10
T20	11.9	12	28	11	10
T25	11.9	12	28	11	10
T27	11.9	12	28	12	10
T30	11.9	12	28	12	10
T40	11.9	12	28	13	10

2025-50 (T)	D (mm)	H (mm)	L (mm)	(g)	(pcs.)
New T10	11.9	34	50	16	10
New T15	11.9	34	50	16	10
New T20	11.9	34	50	16	10
New T25	11.9	34	50	16	10
New T27	11.9	34	50	17	10
New T30	11.9	34	50	17	10
New T40	11.9	34	50	18	10

2025-80 (T)	D (mm)	H (mm)	L (mm)	(g)	(pcs.)
T10	11.9	64	80	40	10
T15	11.9	64	80	40	10
T20	11.9	64	80	42	10
T25	11.9	64	80	42	10
T27	11.9	64	80	45	10
T30	11.9	64	80	45	10
T40	11.9	64	80	50	10

RS2025/7-L28	7 Pieces set/Rail 150mm	(g)
T10, T15, T20, T25, T27, T30, T40		119

RS2025/7-L50	7 Pieces set/Rail 150mm	(g)
T10, T15, T20, T25, T27, T30, T40		140

2025-28 (TH)	D (mm)	H (mm)	L (mm)	(g)	(pcs.)
T10H	11.9	12	28	10	10
T15H	11.9	12	28	10	10
T20H	11.9	12	28	11	10
T25H	11.9	12	28	11	10
T27H	11.9	12	28	12	10
T30H	11.9	12	28	12	10
T40H	11.9	12	28	13	10

RS2025/7-HOLE	7 Pieces set/Rail 150mm	(g)
T10H, T15H, T20H, T25H, T27H, T30H, T40H		119

**⚠** Tamper Resistant TORX® Bit Sockets have less strength due to special design. Make sure to use it correctly.  
Die manipulationssicheren TORX®-Bit-Einsätze haben aufgrund ihres speziellen Designs eine geringere Festigkeit. Achten Sie darauf, sie richtig zu verwenden.  
Les douilles à embouts TORX® à l'abri des manipulations ont une résistance moindre en raison de leur conception spéciale. Veuillez les utiliser correctement.



## 2025-28 / -50 / -80 (T) TORX® Bit Sockets

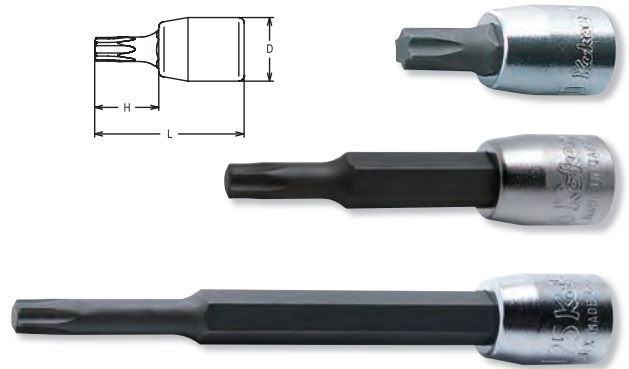
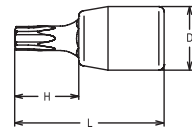

## RS2025/7-L28 Socket Set on Rail



## RS2025/7-L50 Socket Set on Rail



## 2025-28 (TH) Tamper-Resistant TORX® Bit Sockets

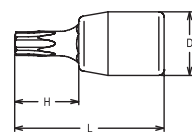

## RS2025/7-HOLE Socket Set on Rail



# Hand Sockets Hand Steckschlüssel Douilles à main

# 1/4"

Z-SERIES  
HAND  
TITANIUM  
SCREWDRIVERS ACCESSORIES  
IMPACT  
SLEEVE-DRIVE  
PROTECTOR  
INDUSTRIAL  
AUTOMOTIVE  
CONSTRUCTION MOTORCYCLE  
SPARE PART

## 2025-28 (IP)



TORXPLUS® Bit Sockets  
TORXPLUS® Bit-Steckschlüssel  
Douilles tournevis, TORXPLUS®

**TORXplus®**

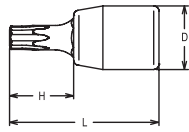

2025-28 (IP)	D (mm)	H (mm)	L (mm)	(g)	(pcs.)
8IP	11.9	12	28	10	10
9IP	11.9	12	28	10	10
10IP	11.9	12	28	10	10
15IP	11.9	12	28	10	10
20IP	11.9	12	28	11	10
25IP	11.9	12	28	11	10
27IP	11.9	12	28	12	10
30IP	11.9	12	28	12	10
40IP	11.9	12	28	13	10

## RS2025/7-IP



Socket Set on Rail  
Steckschlüsselsatz auf Schiene  
Jeu de douilles sur rail



RS2025/7-IP	7 Pieces set/Rail 150mm	(g)
10IP, 15IP, 20IP, 25IP, 27IP, 30IP, 40IP		119

### TORXPLUS® (IP)

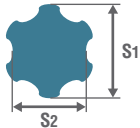

IP	8IP	9IP	10IP	15IP	20IP	25IP	27IP	30IP	40IP	45IP	50IP	55IP	60IP	70IP
S <sub>1</sub> (ref. mm)	2.3	2.5	2.7	3.3	3.9	4.5	5.0	5.6	6.7	7.9	8.9	11.3	13.3	15.6
S <sub>2</sub> (ref. mm)	1.8	1.9	2.1	2.5	3.0	3.4	3.9	4.3	5.2	6.2	6.9	9.0	10.4	12.3

## 2025-28 (IPR)



Tamper-Resistance TORXPLUS® Bit Sockets  
Tamper-Resistance TORXPLUS® Bit-Steckschlüssel  
Douilles tournevis TORXPLUS® avec trou

**TORXplus®**

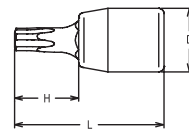

2025-28 (IPR)	D (mm)	H (mm)	L (mm)	(g)	(pcs.)
8IPR	11.9	12	28	10	10
9IPR	11.9	12	28	10	10
10IPR	11.9	12	28	10	10
15IPR	11.9	12	28	10	10
20IPR	11.9	12	28	11	10
25IPR	11.9	12	28	11	10
27IPR	11.9	12	28	12	10
30IPR	11.9	12	28	12	10
40IPR	13.1	12	28	13	10

## RS2025/7-IPR



Socket Set on Rail  
Steckschlüsselsatz auf Schiene  
Jeu de douilles sur rail



RS2025/7-IPR	7 Pieces set/Rail 150mm	(g)
10IPR, 15IPR, 20IPR, 25IPR, 27IPR, 30IPR, 40IPR		119

### TORXPLUS® (IPR)

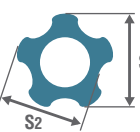

IPR	8IPR	9IPR	10IPR	15IPR	20IPR	25IPR	27IPR	30IPR	40IPR	45IPR	50IPR	55IPR
S <sub>1</sub> (ref. mm)	2.2	2.4	2.6	3.1	3.6	4.1	4.7	5.2	6.3	7.4	8.4	10.6
S <sub>2</sub> (ref. mm)	2.0	2.2	2.4	2.8	3.3	3.8	4.3	4.8	5.7	6.7	7.6	9.7

## 2137



Bit Holder  
Klingenhalter  
Porte-embouts

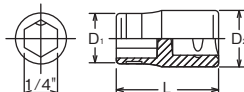

	D <sub>1</sub> (mm)	D <sub>2</sub> (mm)	L (mm)	(g)	(pcs.)
2137	12	12	22.5	13	10

For DIN3126 C6.3 Bits  
Für DIN3126 C6.3 Bits  
Pour DIN3126 C6.3 Embouts

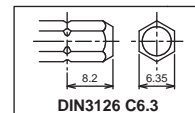

## 2138



Bit Holder  
Klingenhalter  
Porte-embouts

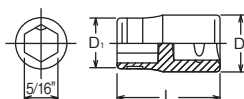

	D <sub>1</sub> (mm)	D <sub>2</sub> (mm)	L (mm)	(g)	(pcs.)
2138	16	16	26	32	10

For DIN3126 C8 Bits  
Für DIN3126 C8 Bits  
Pour DIN3126 C8 Embouts

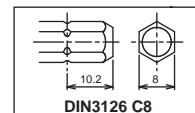

# 1/4" Hand Sockets Hand Steckschlüssel Douilles à main



\* Renewal Kits → 2753RK → P318



**2753PS** Reversible Ratchet (Short)  
Knarre kurz, verstellbar  
Cliquet courte, réversible



	D (mm)	T (mm)	H (mm)	L (mm)	(g)	(pcs.)
<b>2753PS</b>	22	18.7	11.4	75	55	5

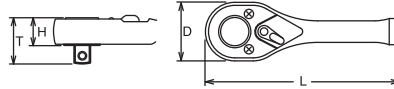

\* Renewal Kits → 2753RK → P318

**2753J** Reversible Ratchet  
Knarre, verstellbar  
Cliquet, réversible



\* Renewal Kits → 2753RK → P318

**2753P** Reversible Ratchet  
Knarre, verstellbar  
Cliquet, réversible



\* Renewal Kits → 2753RK → P318

**2753N** Reversible Ratchet  
Knarre, verstellbar  
Cliquet, réversible



	D (mm)	T (mm)	H (mm)	L (mm)	(g)	(pcs.)
<b>2753J</b>	22	18.7	11.4	115	77	1
<b>2753P</b>	22	18.7	11.4	115	87	1
<b>2753N</b>	22	18.7	11.4	115	90	1

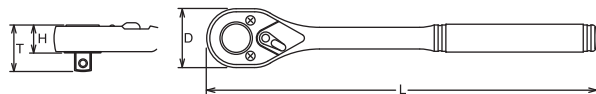

\* Renewal Kits → 2753RK → P318

**2753P-160** Reversible Ratchet (Long)  
Verstellbare Knarre, lang  
Cliquet réversible, longue



	D (mm)	T (mm)	H (mm)	L (mm)	(g)	(pcs.)
<b>2753P-160</b>	22	18.7	11.4	160	107	1

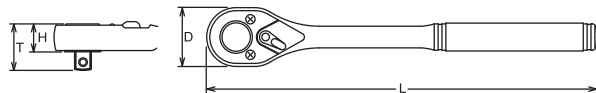

2753P-160 have longer handle than standard, and can be loaded to excessive torque value. In the interest of your own safety always apply load evenly and progressively to avoid breakage and possible injury.

Sie haben einen längeren Griff als Standardprodukte und können mit einem übermäßigen Drehmoment belastet werden. Im Interesse Ihrer eigenen Sicherheit sollten Sie sie immer gleichmäßig und schrittweise belasten, um Brüche und mögliche Verletzungen zu vermeiden.

Z-SERIES  
HAND  
TITANIUM  
ACCESSORIES  
SCREWDRIVERS  
IMPACT  
SLEEVE-DRIVE  
PROTECTOR  
INDUSTRIAL  
AUTOMOTIVE  
MOTORCYCLE  
CONSTRUCTION  
SPARE PART

# Hand Sockets Hand Steckschlüssel Douilles à main

## 1/4"

Z-SERIES  
HAND  
TITANIUM  
SCREWDRIVERS ACCESSORIES  
IMPACT  
SLEEVE-DRIVE  
PROTECTOR  
INDUSTRIAL  
AUTOMOTIVE  
MOTORCYCLE  
CONSTRUCTION  
SPARE PART

**2753JB** Reversible Ratchet with quick release button  
Knarre, verstellbar mit Entriegelungsknopf  
Cliquet, réversible avec bouton de débrayage 



\* Renewal Kits → 2753BRK → P318

**2753PB** Reversible Ratchet with quick release button  
Knarre, verstellbar mit Entriegelungsknopf  
Cliquet, réversible avec bouton de débrayage 



\* Renewal Kits → 2753BRK → P318

**2753NB** Reversible Ratchet with quick release button  
Knarre, verstellbar mit Entriegelungsknopf  
Cliquet, réversible avec bouton de débrayage 



\* Renewal Kits → 2753BRK → P318

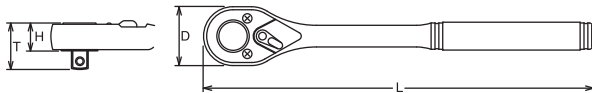

	D (mm)	T (mm)	H (mm)	L (mm)	(g)	(pce.)
2753JB	22	18.7	11.4	115	77	1
2753PB	22	18.7	11.4	115	87	1
2753NB	22	18.7	11.4	115	90	1

 **Reversible Ratchet with Quick Release Button :**  
Sockets and accessories are safely locked. By pushing the button the sockets or extension bars are released from the ratchet.

**Umstellbare Knarre mit Entriegelungsknopf :**

Steckschlüssel und Zubehörteile sitzen sicher und fest - ein Druck auf den Knopf genügt, um sie zu lösen.

**Cliquet réversible à verrouillage :**

Les douilles et accessoires sont fixés. En poussant le bouton ils se libèrent facilement.

**2774JS** Flexible Ratchet, reversible  
Gelenk-Knarre, verstellbar  
Cliquet articulé, réversible



\* Renewal Kits → 2753BRK → P318

**2774PS** Flexible Ratchet, reversible  
Gelenk-Knarre, verstellbar  
Cliquet articulé, réversible



\* Renewal Kits → 2753BRK → P318

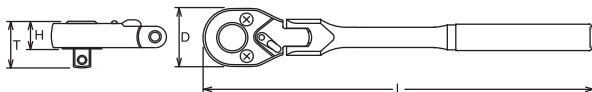

	D (mm)	T (mm)	H (mm)	L (mm)	(g)	(pce.)
2774JS	22	18.7	11.4	116	113	1
2774PS	22	18.7	11.4	116	110	1

# 1/4" Hand Sockets Hand Steckschlüssel Douilles à main



**2774J** Flexible Ratchet, reversible  
Gelenk-Knarre, verstellbar  
Cliquet articulé, réversible



**2774P** Flexible Ratchet, reversible  
Gelenk-Knarre, verstellbar  
Cliquet articulé, réversible



**2774N** Flexible Ratchet, reversible  
Gelenk-Knarre, verstellbar  
Cliquet articulé, réversible

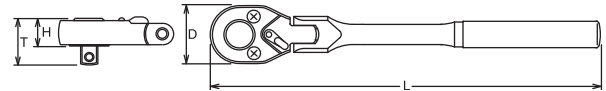

	D (mm)	T (mm)	H (mm)	L (mm)	(g)	(pcs.)
2774J	22	18.7	11.4	161	130	1
2774P	22	18.7	11.4	161	126	1
2774N	22	18.7	11.4	161	130	1



\* Renewal Kits -> 2755RK -> P319

**2755** Ratchet Adaptor  
Aufsteckknarre  
Cliquet adaptable

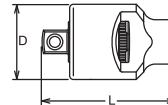

	D (mm)	L (mm)	(g)	(pcs.)
2755	26	40	80	10

**2756** Quick Spinner  
Rändel-Drehscheibe  
Lanceur

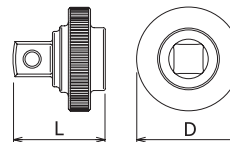

	D (mm)	L (mm)	(g)	(pcs.)
2756	22	20	19	10

**2762** Flexible Extension Bar  
Biegsame Verlängerung  
Rallonge flexible

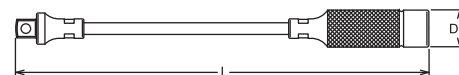

	D (mm)	L (mm)	(g)	(pcs.)
2762	13	300	90	2

**2120** Magnetic Head  
Magnetkopf  
Tête aimantée

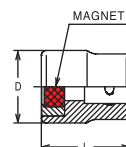

	D (mm)	L (mm)	(g)	(pcs.)
2120	14.3	17.5	21	10

Z-SERIES  
HAND  
TITANIUM  
ACCESSORIES  
SCREWDRIVERS  
IMPACT  
SLEEVE-DRIVE  
PROTECTOR  
INDUSTRIAL  
AUTOMOTIVE  
MOTORCYCLE  
CONSTRUCTION  
SPARE PART

# Hand Sockets Hand Steckschlüssel Douilles à main

# 1/4"

Z-SERIES  
HAND  
TITANIUM  
SCREWDRIVERS  
ACCESSORIES  
IMPACT  
SLEEVE-DRIVE  
PROTECTOR  
INDUSTRIAL  
AUTOMOTIVE  
MOTORCYCLE  
CONSTRUCTION  
SPARE PART

## 2760 Extension Bars Verlängerungen Rallonges

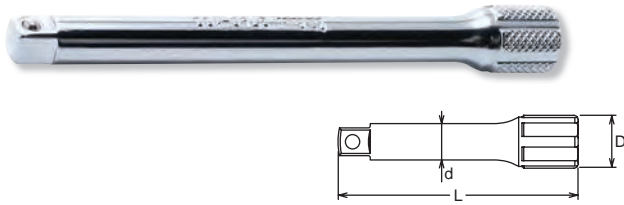

## PK2760/6 Extension Set in Plastic Box Verlängerungen in Kunststoffkassette Jeu de rallonges en boîte plastique



## 2763 Wobble-Fix Extension Bars Winkel-Verlängerungen Rallonges angulaires

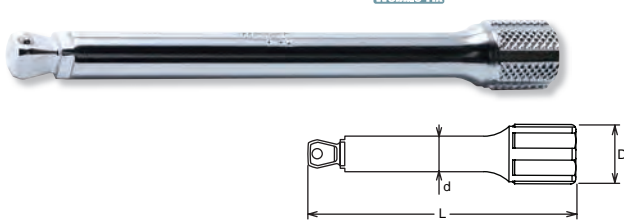

## PK2763/6 Wobble-Fix Extension Bars in Plastic Box Winkel-Verlängerungen in Kunststoffkassette Jeu de rallonges angulaires en boîte plastique



**⚠** The Wobble-Fix Extension Bar has less strength than normal extension bar due to its specific design with a reduced square drive. Make sure to use it correctly.

Die Wobble-Fix Verlängerungen haben aufgrund ihrer speziellen Konstruktion mit einem reduzierten Vierkantantrieb eine geringere Festigkeit als eine normale Verlängerung. Achten Sie darauf, sie richtig zu verwenden.

La barre d'extension wobble-fix est moins résistante qu'une barre d'extension normale en raison de sa conception spécifique avec un carré d'entraînement réduit. Veillez à l'utiliser correctement.

## 2768J Hinge Handle Gelenkgriff Poignée articulée



## 2768P Hinge Handle Gelenkgriff Poignée articulée



## 2768N Hinge Handle Gelenkgriff Poignée articulée



	D (mm)	d (mm)	L (mm)	(g)	(pcs.)
2760-28	12.3	8.2	28	14	10
2760-50	12.3	8.2	50	23	10
2760-75	12.3	8.2	75	35	10
2760-100	12.3	8.2	100	44	10
2760-150	12.3	8.2	150	63	10
2760-200	12.3	8	200	83	10
2760-250	12.3	8	250	103	10
2760-300	12.3	8	300	122	2
2760-350	12.3	8	350	145	2
2760-400	12.3	8	400	160	2
2760-600	12.3	8	600	240	2

## PK2760/6 6 Pieces Set/△=430g PLASTIC TRAY

### Extension Bars

2760 Extension Bars  
28, 50, 100, 150, 200, 250

Rotation and general handling of extensions with oily hands is greatly improved with the **Koken** developed 6 point knurling. Also the **Koken** 6 point knurling stops the extensions from rolling around the work area.

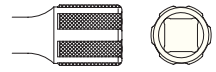

Durch die von **Koken** entwickelte 6 fache Rändelung wird die Handhabung deutlich erleichtert. Außerdem wird das Herumrollen der Verlängerungen wirksam verhindert.

La manipulation des rallonges est grandement facilitée par le profil moleté développé par **Koken**. Ce même profil empêche le roulement intempêtif des rallonges sur le plan de travail.



	D (mm)	d (mm)	L (mm)	(g)	(pcs.)
2763-28	12.3	8.2	28	14	10
2763-50	12.3	8.2	50	23	10
2763-75	12.3	8.2	75	33	10
2763-100	12.3	8.2	100	43	10
2763-150	12.3	8.2	150	62	10
2763-200	12.3	8	200	80	10
2763-250	12.3	8	250	100	10

## PK2763/6 6 Pieces Set/△=420g PLASTIC TRAY

### Extension Bars

2763 Wobble-Fix Extension Bars  
28, 50, 100, 150, 200, 250

### Wobble-Fix Extension Bar

Two way usage

- In a fixed position, as a normal extension bar
- In a half-fixed position, as a flexible extension bar providing a 15° angle operation

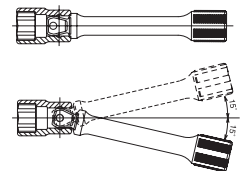

### Winkel-Verlängerungen

Winkelverlängerungen lassen sich in zwei Einstellungen verwenden

- voll eingesteckt und starr,
- halb eingesteckt, mit einem Arbeitswinkel von 15°.

### Rallonges angulaires

Deux utilisations possibles

- comme rallonge normale, dans une position fixe
- comme une rallonge angulaire avec une possibilité d'inclinaison jusqu'à 15°

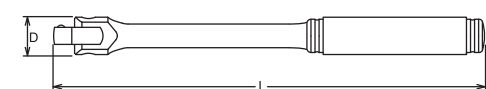

\* Renewal Kits → 2768RK → P321

	D (mm)	L (mm)	(g)	(pcs.)
2768J	14	130	73	5
2768P	14	130	70	10
2768N	14	130	86	10

2769N	H (mm)	L (mm)	(g)	(pcs.)
150	50	150	73	2
220	120	220	100	2

 Plastic or rubber handles are not intended to act as insulation.

Plastik-oder Gummigriffe stellen keinen Isolierschutz dar.

Les poignées en plastique ou en caoutchouc ne garantissent aucune isolation électrique.

## 2769N-150 / -220

Spin Type Handle  
Drehgriff  
Poignée emmanchée 

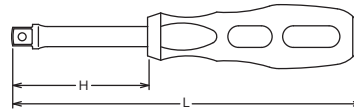

WOBBLE-FIX  
EXTENSION BAR



2769NWF	H (mm)	L (mm)	(g)	(pcs.)
150	50	150	73	2
220	120	220	100	2

## 2769NWF-150 / -220

Spin Type Handle(Wobble-Fix)  
Drehgriff, Wobble-Fix  
Poignée emmanchée, angulaire 

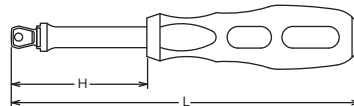

### Wobble-Fix Extension Bar

Two way usage:  
One for as a flexible extension bar to provide at 15° angle operation, the other for use as a normal extension bar.

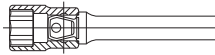

### Woble-Fix Verlängerung

Zwei Verwendungsmöglichkeiten:  
zum einen als flexible Verlängerung für den Betrieb in einem Winkel von 15°, zum anderen als normale Verlängerung.

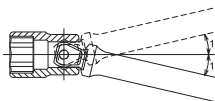

### Barre d'extension Woble-Fix

Utilisation double:  
l'une comme barre d'extension flexible pour fournir un angle de 15°, l'autre comme barre d'extension normale.

2769H	L (mm)	(g)	(pcs.)
2769H	160	180	5

## 2769H

Folding Socket Driver  
Klapp-Drehgriff  
Poignée tournevis articulée

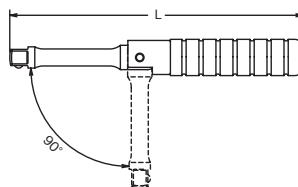
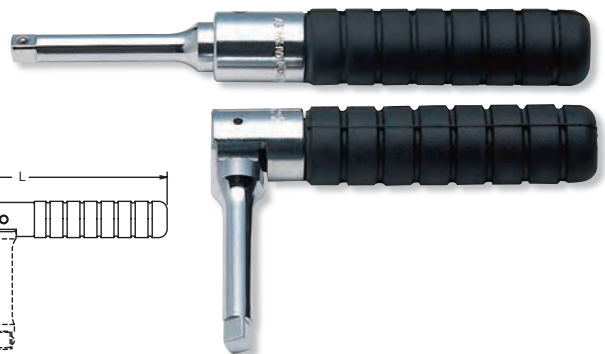

Z-SERIES  
HAND  
TITANIUM  
SCREWDRIVERS ACCESSORIES  
IMPACT  
SLEEVE-DRIVE  
PROTECTOR  
INDUSTRIAL  
AUTOMOTIVE  
MOTORCYCLE  
CONSTRUCTION  
SPARE PART

**2770** Universal Joint  
Gelenk-Einsatz  
Cardan universel

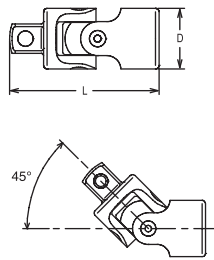

	D (mm)	L (mm)	(g)	(pcs.)
2770	13	33	20	10

**2771** Universal Joint  
Gelenk-Einsatz  
Joint articulé

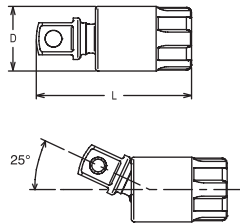

	D (mm)	L (mm)	(g)	(pcs.)
2771	12.7	31	20	10



**2780** Speed Handle  
Winde  
Vilebrequin

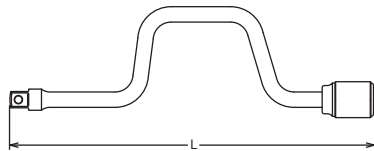

	L (mm)	(g)	(pcs.)
2780	350	250	1

**2785** T-Handle  
T-Griff  
Poignée coulissante

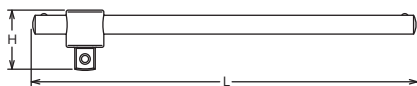

	H (mm)	L (mm)	(g)	(pcs.)
2785	21.3	115	36	10

**2233A** Adaptor  
Verbindungsstück  
Augmentateur

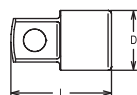





	(sq.)	(sq.)	D (mm)	L (mm)	(g)	(pcs.)
2233A	1/4"	3/8"	13	22	16	10

# 1/4"



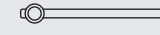

Hand Sockets  
Hand Steckschlüssel  
Douilles à main

Z-SERIES  
HAND  
TITANIUM  
ACCESSORIES  
SCREWDRIVERS  
IMPACT  
SLEEVE-DRIVE  
PROTECTOR  
INDUSTRIAL  
AUTOMOTIVE  
MOTORCYCLE  
CONSTRUCTION  
SPARE PART

<b>ESH2001</b> 16 Pieces Set/△=630g	
METAL CASE:W160xH100xT28mm	
Sockets	Accessories
 <b>2410M</b> Surface Drive Sockets 4, 5, 5.5, 6, 7, 8, 9, 10, 11, 12, 13	 <b>2753J</b>  <b>2763-50</b>  <b>2760-150</b>  <b>2770</b>  <b>2785</b>

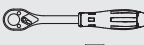

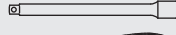

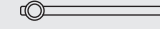
**ESH2001** Socket Set  
Steckschlüssel Satz  
Jeu de clés à douille



<b>2251M</b> 17 Pieces Set/△=725g	
METAL CASE:W192xH122xT30mm	
Sockets	Accessories
 <b>2400M</b> 6-pt. Sockets 4, 4.5, 5, 5.5, 6, 7, 8, 9, 10, 11, 13	 <b>2753J</b>  <b>2760-50</b>  <b>2760-150</b>  <b>2768J</b>  <b>2770</b>  <b>2785</b>

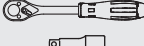

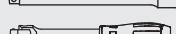

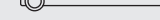



**2251M / 2251A** Socket Set  
Steckschlüssel Satz  
Jeu de clés à douille



<b>2251A</b> 15 Pieces Set/△=700g	
METAL CASE:W192xH122xT30mm	
Sockets	Accessories
 <b>2400A</b> 6-pt. Sockets 3/16, 7/32, 1/4, 9/32, 5/16, 11/32, 3/8, 7/16, 1/2	 <b>2753J</b>  <b>2760-50</b>  <b>2760-150</b>  <b>2768J</b>  <b>2770</b>  <b>2785</b>

**2258M** Socket Set  
Steckschlüssel Satz  
Jeu de clés à douille

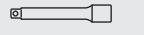

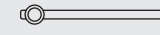
<b>2258M</b> 31 Pieces Set/△=965g	
METAL CASE:W240xH100xT32mm	
Sockets	Accessories
 <b>2400M</b> 6-pt. Sockets 4, 4.5, 5, 5.5, 6, 7, 8, 9, 10, 11, 13  <b>2000.28</b> Bit Sockets 1, 2, 3  <b>2005.25</b> Bit Sockets 4, 6  <b>2010M.25</b> Bit Sockets 3, 4, 5, 6, 8  <b>2025.28</b> Bit Sockets T10, T15, T20, T25, T30	 <b>2753J</b>  <b>2760-100</b>  <b>2769N-150</b>  <b>2770</b>  <b>2785</b>

# Hand Sockets Hand Steckschlüssel Douilles à main

# 1/4"

Z-SERIES  
HAND  
TITANIUM  
SCREWDRIVERS  
ACCESSORIES  
IMPACT  
SLEEVE-DRIVE  
PROTECTOR  
INDUSTRIAL  
AUTOMOTIVE  
MOTORCYCLE  
CONSTRUCTION  
SPARE PART

**2259M** Socket Set  
Steckschlüssel Satz  
Jeu de clés à douille



2259M		31 Pieces Set/△=991g	
METAL CASE:W240xH100xT32mm			
Sockets		Accessories	
	<b>2400M</b> 6-pt. Sockets 4, 4.5, 5, 5.5, 6, 7, 8, 9, 10, 11, 13		<b>2774JS</b>
	<b>2000.28</b> Bit Sockets 1, 2, 3		<b>2760-100</b>
	<b>2005.25</b> Bit Sockets 4, 6		<b>2769N-150</b>
	<b>2010M.25</b> Bit Sockets 3, 4, 5, 6, 8		<b>2770</b>
	<b>2025.28</b> Bit Sockets T10, T15, T20, T25, T30		<b>2785</b>

**2263A** Socket Set  
Steckschlüssel Satz  
Jeu de clés à douille



2263A		29 Pieces Set/△=940g	
METAL CASE:W240xH100xT32mm			
Sockets		Accessories	
	<b>2400A</b> 6-pt. Sockets 1/8, 5/32, 3/16, 7/32, 1/4, 9/32, 5/16, 11/32, 3/8, 7/16, 1/2		<b>2753N</b>
	<b>2000.28</b> Bit Sockets 1, 2, 3		<b>2760-100</b>
	<b>2010A.25</b> Bit Sockets 1/8, 5/32, 3/16, 7/32, 1/4, 9/32, 5/16		<b>2769N-150</b>
	<b>2025.28</b> Bit Sockets T10, T15, T20, T25, T30		<b>2770</b>
			<b>2785</b>

**2275** Socket Set  
Steckschlüssel Satz  
Jeu de clés à douille



2275		19 Pieces Set/△=880g	
METAL CASE:W192xH122xT30mm			
Sockets		Accessories	
	<b>2400M</b> 6-pt. Sockets 5.5, 6, 7, 8, 10, 12, 13		<b>2753J</b>
	<b>2000.28</b> Bit Sockets 1, 2, 3		<b>2763-50</b>
	<b>2005.25</b> Bit Sockets 6, 8		<b>2769N-150</b>
	<b>2010M.25</b> Bit Sockets 3, 4, 5, 6		

**2276** Socket Set with Bits and Accessories  
Bit Satz mit Zubehör  
Jeu d'embouts et avec accessoires



2276		19 Pieces Set/△=640g	
METAL CASE:W192xH122xT30mm			
Bits		Accessories	
	<b>108P</b> PH Bits 1, 2, 3		<b>2753PS</b>
	<b>108S</b> Slotted Bits 4, 5, 6		<b>2769N-150</b>
	<b>108H</b> Hex Bits 3, 4, 5, 6		<b>2137</b>
	<b>108T</b> TORX® Bits T10, T15, T20, T25, T27, T30		

**2277** Socket Set  
Steckschlüssel Satz  
Jeu de clés à douille





2277		21 Pieces Set/△=1,240g	
METAL CASE:W310xH86xT50mm			
Sockets		Accessories	
	<b>2400M</b> 6-pt. Sockets 5.5, 6, 7, 8, 9, 10, 11, 12, 13		<b>2753J</b>
	<b>2300M</b> 6-pt. Deep Sockets 5.5, 6, 7, 8, 9, 10, 11, 12, 13		<b>2763-75</b>
			<b>2769N-150</b>

# 1/4"



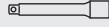

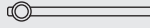
Hand Sockets  
Hand Steckschlüssel  
Douilles à main

Z-SERIES  
HAND  
TITANIUM  
ACCESSORIES  
SCREWDRIVERS  
IMPACT  
SLEEVE-DRIVE  
PROTECTOR  
INDUSTRIAL  
AUTOMOTIVE  
MOTORCYCLE  
CONSTRUCTION  
SPARE PART

P2201AM		25 Pieces Set/△=800g	
PLASTIC CASE:W245xH120xT45mm			
Sockets	Accessories		
<p><b>2400M</b> 6-pt. Sockets 4, 5, 5.5, 6, 7, 8, 9, 10, 11, 12, 13</p> <p><b>2400A</b> 6-pt. Sockets 3/16, 7/32, 1/4, 9/32, 5/16, 11/32, 3/8, 7/16, 1/2</p>		<p>2753J</p>	
		<p>2760-100</p>	
		<p>2769N-150</p>	
		<p>2770</p>	
		<p>2785</p>	

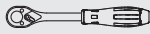

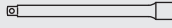

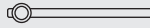
**P2201AM** Socket Set  
Steckschlüssel Satz  
Jeu de clés à douille

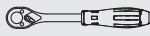

P2251M		18 Pieces Set/△=770g	
PLASTIC CASE:W245xH120xT45mm			
Sockets	Accessories		
<p><b>2400M</b> 6-pt. Sockets 4, 4.5, 5, 5.5, 6, 7, 8, 9, 10, 11, 12, 13</p>		<p>2753J</p>	
		<p>2760-50</p>	
		<p>2760-150</p>	
		<p>2768J</p>	
		<p>2770</p>	
		<p>2785</p>	

**P2251M** Socket Set  
Steckschlüssel Satz  
Jeu de clés à douille

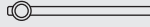

P2258M		31 Pieces Set/△=860g	
PLASTIC CASE:W245xH120xT45mm			
Sockets	Accessories		
<p><b>2400M</b> 6-pt. Sockets 4, 5, 5.5, 6, 7, 8, 9, 10, 11, 12, 13</p> <p><b>2000.28</b> Bit Sockets 1, 2, 3</p> <p><b>2005.25</b> Bit Sockets 4, 6</p> <p><b>2010M.25</b> Bit Sockets 3, 4, 5, 6, 8</p> <p><b>2025.28</b> Bit Sockets T10, T15, T20, T25, T30</p>		<p>2753J</p>	
		<p>2760-100</p>	
		<p>2769N-150</p>	
		<p>2770</p>	
		<p>2785</p>	

**P2258M** Socket Set  
Steckschlüssel Satz  
Jeu de clés à douille



ABS Case - PE foam insert  
Kunststoffkassette - Weichschaumeinlage  
Coffret en ABS - Inserts en mousse

Z-SERIES  
HAND  
TITANIUM  
SCREWDRIVERS ACCESSORIES  
IMPACT  
SLEEVE-DRIVE  
PROTECTOR  
INDUSTRIAL  
AUTOMOTIVE  
MOTORCYCLE  
CONSTRUCTION  
SPARE PART

## 3400M / 3400A

6-point Sockets  
6-kant Steckschlüssel  
Douilles 6-pans

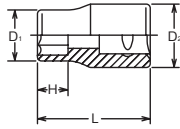

## 3405M / 3405A

12-point Sockets  
12-kant Steckschlüssel  
Douilles 12-pans

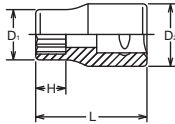

## FLAT DRIVE®

Flat drive is designed to guarantee a flat surface contact between the socket and the bolt/nut. The Flat contact reduces wear and allows to transmit a higher torque value. The Flat Drive System is also used for the square drive end as well as the hexagonal or bi-hexagonal openings of the socket.

Das Flat Drive Design sorgt für die optimale Kraftübertragung zwischen den Flächen des Steckschlüssels und der Schraube. Dies erlaubt eine Übertragung von höheren Drehmomenten. Das Flat Drive System findet ebenfalls bei allen Antriebsvierkantente sowie bei 6-kant und 12-kant Profilen Verwendung.

Le profil Flat Drive garantit un contact optimal entre la douille et l'écrou. Ce contact « à plat » réduit l'usure et permet la transmission d'un couple plus élevé. Ce système Flat Drive est utilisé pour tous les carrés conducteurs ainsi que pour toutes nos douilles 6-pans et 12-pans.

## RS3400M/12 RS3405M/12

Socket Set on Rail  
Steckschlüsselsatz auf Schiene  
Jeu de douilles sur rail



## RS3400A/9 RS3405A/9

Socket Set on Rail  
Steckschlüsselsatz auf Schiene  
Jeu de douilles sur rail



3400M 3405M (mm)	D <sub>1</sub> (mm)	D <sub>2</sub> (mm)	H (mm)	L (mm)	(g)	(pcs.)
5	8.3	17.3	5	26	20	10
5.5	8.9	17.3	5.5	26	20	10
6	9.9	17.3	6	26	20	10
7	10.8	17.3	6.5	26	20	10
8	12	17.3	7	26	22	10
9	13.3	17.3	7.5	26	23	10
10	14.5	17.3	8	26	24	10
11	15.8	17.3	8.5	26	25	10
12	16.8	17.3	9	26	25	10
13	18	17	9.5	26	24	10
14	19.5	18.5	11	27	31	10
15	20.8	19.5	11.5	28	39	10
16	22	20	12	28	42	10
17	23.3	21.5	12.5	29	51	10
18	24.5	22.5	13	30	51	10
19	25.8	23.5	13.5	30	63	10
20	27	24.5	14	31	75	10
21	28	26	14.5	32	77	10
22	29.5	26.5	15	32	82	10
23	30.8	27.5	15.5	33	95	10
24	32	28.5	16	34	102	10
25	33.3	29.5	16.5	34	115	5
26	34.5	30.5	17	35	129	5

3400A 3405A (inch)	D <sub>1</sub> (mm)	D <sub>2</sub> (mm)	H (mm)	L (mm)	(g)	(pcs.)
3/16	8.3	17.3	5	26	20	10
1/4	10.3	17.3	6	26	20	10
9/32	10.8	17.3	6.5	26	20	10
5/16	12	17.3	7	26	22	10
11/32	13.3	17.3	7.5	26	23	10
3/8	13.9	17.3	8	26	23	10
13/32	13.3	17.3	7.5	26	23	10
7/16	15.8	17.3	8.5	26	25	10
1/2	18	17	9.5	26	24	10
9/16	19.5	18.5	11	27	31	10
19/32	20.8	19.5	11.5	28	39	10
5/8	22	20	12	28	42	10
11/16	24.5	22.5	13	30	51	10
3/4	25.8	23.5	13.5	30	63	10
25/32	27	24.5	14	31	75	10
13/16	28	26	14.5	32	77	10
7/8	29.5	26.5	15	32	82	10
15/16	32	28.5	16	34	102	10
1	34.5	30.5	17	35	132	5

RS3400M/12	12 Pieces Set/Rail 300mm	(g)
8, 9, 10, 11, 12, 13, 14, 15, 16, 17, 18, 19		465

RS3405M/12	12 Pieces Set/Rail 300mm	(g)
8, 9, 10, 11, 12, 13, 14, 15, 16, 17, 18, 19		465

RS3400A/9	9 Pieces Set/Rail 200mm	(g)
1/4, 5/16, 3/8, 7/16, 1/2, 9/16, 5/8, 11/16, 3/4		333

RS3405A/9	9 Pieces Set/Rail 200mm	(g)
1/4, 5/16, 3/8, 7/16, 1/2, 9/16, 5/8, 11/16, 3/4		333

3410M (mm)	D <sub>1</sub> (mm)	D <sub>2</sub> (mm)	H (mm)	L (mm)	(g)	(pcs.)
5.5	8.9	17.3	5.5	26	20	10
6	9.9	17.3	6	26	20	10
7	10.8	17.3	6.5	26	20	10
8	12	17.3	7	26	22	10
9	13.3	17.3	7.5	26	23	10
10	14.5	17.3	8	26	24	10
11	15.8	17.3	8.5	26	25	10
12	16.8	17.3	9	26	25	10
13	18	17	9.5	26	24	10
14	19.5	18.5	11	27	31	10
15	20.8	19.5	11.5	28	39	10
16	22	20	12	28	42	10
17	23.3	21.5	12.5	29	51	10
18	24.5	22.5	13	30	51	10
19	25.8	23.5	13.5	30	63	10
20	27	24.5	14	31	75	10
21	28	26	14.5	32	77	10
22	29.5	26.5	15	32	82	10
23	30.8	27.5	15.5	33	95	10
24	32	28.5	16	34	102	10



## 3410M

Surface Drive Sockets  
Surface Drive Steckschlüssel  
Douilles, Surface Drive

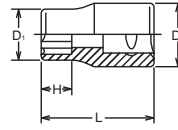

## SURFACE DRIVE

Surface drive sockets are designed to retain contact with the flat sides of the nut in order to transmit high torque and reduce nut wear. These sockets are ideal for using on polished nuts, aluminum nuts and nuts with worn out points.

Das Profil unserer Surface-Drive Steckschlüssel greift die Schraube an deren Flächen. Dies sichert eine höhere Kraftübertragung und verhindert ein Durchrutschen des Steckschlüssels. Diese Steckschlüssel eignen sich besonders für polierte Schrauben, Aluminiumschrauben und Schrauben bei denen die Ecken bereits abgerundet sind.

Notre profil Surface Drive assure le contact entre la douille et les plats de l'écrou. Ceci réduit l'usure et permet la transmission d'un couple plus élevé. C'est une solution idéale pour les écrous polies, celles en aluminium ou arrondies.

RS3410M/12	12 Pieces Set/Rail 300mm	(g)
8, 9, 10, 11, 12, 13, 14, 15, 16, 17, 18, 19		468

## RS3410M/12

Socket Set on Rail  
Steckschlüsselsatz auf Schiene  
Jeu de douilles sur rail



3400W 3405W (W)	D <sub>1</sub> (mm)	D <sub>2</sub> (mm)	H (mm)	L (mm)	(g)	(pcs.)
1/8	13.3	17.3	7.5	26	22	10
3/16	15.8	17.3	8.5	26	25	10
1/4	18	17	9.5	26	24	10
5/16	20.8	19.5	11.5	28	39	10
3/8	24.5	22.5	13	30	51	10
7/16	28	26	14.5	32	81	10
1/2	30.8	27.5	15.5	33	103	10
9/16	34.5	30.5	17	35	128	5

## 3400W

6-point Whitworth Sockets  
6-kant Steckschlüssel, Whitworth  
Douilles à 6-pans Whitworth

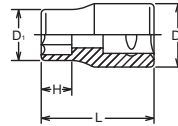

## 3405W

12-point Whitworth Sockets  
12-kant Steckschlüssel, Whitworth  
Douilles à 12-pans Whitworth

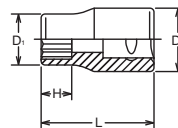

RS3400W/7	7 Pieces Set/Rail 200mm	(g)
1/8, 3/16, 1/4, 5/16, 3/8, 7/16, 1/2		389

## RS3400W/7

Socket Set on Rail  
Steckschlüsselsatz auf Schiene

## RS3405W/7

Socket Set on Rail  
Steckschlüsselsatz auf Schiene

RS3405W/7	7 Pieces Set/Rail 200mm	(g)
1/8, 3/16, 1/4, 5/16, 3/8, 7/16, 1/2		389



## BS W



BS - W	BS	3/16BS	1/4BS	5/16BS	3/8BS	7/16BS	1/2BS	9/16BS	5/8BS	11/16BS	3/4BS	7/8BS
	W	1/8W	3/16W	1/4W	5/16W	3/8W	7/16W	1/2W	9/16W	5/8W	11/16W	3/4W
S	(ref. mm)	8.64	11.30	13.34	15.24	18.03	20.83	23.37	25.65	27.94	30.48	33.35

## 3415M / 3415A

 Double 4-point Sockets  
Doppelvierkant Steckschlüssel  
Douilles 4-pans, doubles

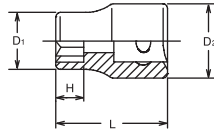

## 3425

 TORX® Sockets  
TORX® Steckschlüssel  
Douilles TORX®

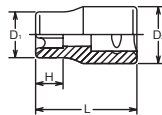

## RS3425/9

 Socket Set on Rail  
Steckschlüsselsatz auf Schiene  
Jeu de douilles sur rail



## RSX425/14

 Socket Set on Rail  
Steckschlüsselsatz auf Schiene  
Jeu de douilles sur rail



### TORX® (E)

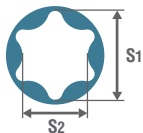

E	E4	E5	E6	E7	E8	E10	E11	E12	E14	E16	E18	E20	E22	E24	E26	E28	E30	E32
S <sub>1</sub> (ref. mm)	3.7	4.6	5.6	6.1	7.4	9.3	9.9	11.0	12.8	14.6	16.5	18.3	20.1	22.0	23.7	25.5	27.3	29.0
S <sub>2</sub> (ref. mm)	2.7	3.3	4.0	4.3	5.3	6.8	7.1	7.9	9.2	10.5	11.9	13.2	14.8	15.7	17.5	18.3	20.0	21.3

## 3400LH

 LHSTIX® Sockets  
Steckschlüssel mit LHSTIX® Profil  
Douilles au profil LHSTIX®

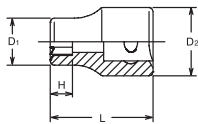

## RS3400LH/7

 Socket Set on Rail  
Steckschlüsselsatz auf Schiene  
Jeu de douilles sur rail



### LHSTIX®

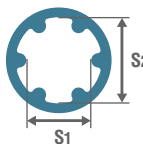

LH-S	LH-5S	LH-6S	LH-8S	LH-10S	LH-12S	LH-14S	LH-16S
S <sub>1</sub> (ref. mm)	5.6	6.8	9.0	11.3	13.6	15.8	18.1
S <sub>2</sub> (ref. mm)	7.5	9.0	12.0	15.0	18.0	21.0	24.0

3415M (mm)	D <sub>1</sub> (mm)	D <sub>2</sub> (mm)	H (mm)	L (mm)	(g)	(pcs.)
5.5	10.8	17.4	5.5	26	21	10
6	12	17.3	6	26	26	10
7	13.3	17.4	6.5	26	26	10
8	14.5	17.3	7	26	26	10
10	16.8	17.3	8	26	27	10
12	20.8	19.5	9	27	43	10
13	21.9	20	9.5	27	46	10

3415A (inch)	D <sub>1</sub> (mm)	D <sub>2</sub> (mm)	H (mm)	L (mm)	(g)	(pcs.)
1/4	12	17.3	6	26	24	10
5/16	14.5	17.3	7	26	26	10
11/32	15.8	17.3	7.5	26	27	10
3/8	16.8	17.3	8	26	27	10
7/16	19.5	18.5	8.5	27	37	10
1/2	22	20	9.5	27	46	10

3425 (E)	D <sub>1</sub> (mm)	D <sub>2</sub> (mm)	H (mm)	L (mm)	(g)	(pcs.)
E 4	5.6	17.3	4.6	26	18	10
E 5	7	17.3	5.2	26	20	10
E 6	8.3	17.3	5.4	26	21	10
E 7	8.9	17.3	6.6	26	22	10
E 8	9.9	17.3	7	26	23	10
E10	12	17.3	8.2	26	24	10
E11	13.3	17.3	8.7	26	25	10
E12	14.5	17.3	9.3	26	26	10
E14	15.8	17.3	10.6	26	27	10
E16	18	17	11.8	26	27	10

RS3425/9	9 Pieces Set/Rail 200mm	(g)
E4, E5, E6, E7, E8, E10, E12, E14, E16		239

RSX425/14	14 Pieces Set/Rail 300mm	(g)
2425	1/4"	E4, E5, E6, E7, E8
3425	3/8"	E10, E11, E12, E14
4425	1/2"	E16, E18, E20, E22, E24
		550

3400LH (LH-S)	D <sub>1</sub> (mm)	D <sub>2</sub> (mm)	H (mm)	L (mm)	(g)	(pcs.)
5S	10.8	17.3	5	26	20	10
6S	12	17.3	5.6	26	22	10
8S	15.8	17.3	6.8	26	25	10
10S	18	17	8	26	25	10
12S	22	20	9.2	28	42	10
14S	24.5	22.5	10.4	30	51	10
16S	28	26	11.6	32	77	10

RS3400LH/7	7 Pieces Set/Rail 200mm	(g)
5S, 6S, 8S, 10S, 12S, 14S, 16S		315

TORX® is a registered trademark of CAMCAR Innovations®.  
TORX® ist ein registriertes Markenzeichen der Firma CAMCAR Innovations®.  
TORX® est une marque déposée de CAMCAR Innovations®.

LHSTIX® is a registered trademark of OSG SYSTEM PRODUCTS CO., LTD.  
LHSTIX® ist ein registriertes Markenzeichen der Firma OSG SYSTEM PRODUCTS CO., LTD.  
LHSTIX® est une marque déposée de OSG SYSTEM PRODUCTS CO., LTD.

# 3/8"

Hand Sockets  
Hand Steckschlüssel  
Douilles à main

3450M (mm)	D <sub>1</sub> (mm)	D <sub>2</sub> (mm)	H (mm)	L (mm)	(g)	(pcs.)
8	12	17.3	5	26	21	10
10	14.5	17.3	6	26	24	10
11	15.8	17.3	6.5	26	26	10
12	16.8	17.3	7	26	26	10
13	18	17	8	26	28	10
14	19.5	18.5	8.5	27	34	10
15	20.8	19.5	9	27	42	10
16	22	20	9	27	50	10
17	23.3	21.5	9.5	28	62	10
18	24.5	22.5	10.5	29	64	10
19	25.8	23.3	11.5	29	66	10
21	28	26	12	29	85	10
22	29.5	27	12.5	29	90	10
24	32	30	14.5	31	102	10

3450A (inch)	D <sub>1</sub> (mm)	D <sub>2</sub> (mm)	H (mm)	L (mm)	(g)	(pcs.)
1/4	10.3	17.4	3.5	26	19	10
5/16	12	17.4	5	26	21	10
3/8	13.9	17.4	6	26	24	10
7/16	15.8	17.4	6.5	26	26	10
1/2	18	17	8	26	28	10
9/16	19.5	18.5	8.5	27	34	10
5/8	22	20	9	27	50	10
11/16	24.6	22.5	10.5	29	64	10
3/4	26	23.5	11.5	29	66	10

RS3450M/8	8 Pieces Set/Rail 200mm	(g)
8, 10, 11, 12, 13, 14, 17, 19		310
RS3450M/10	10 Pieces Set/Rail 250mm	(g)
10, 11, 12, 13, 14, 15, 17, 19, 21, 22		500

RS3450A/9	9 Pieces Set/Rail 200mm	(g)
1/4, 5/16, 3/8, 7/16, 1/2, 9/16, 5/8, 11/16, 3/4		360

3450MH (mm)	D (mm)	H <sub>1</sub> (mm)	H <sub>2</sub> (mm)	L (mm)	(g)	(pcs.)
8	12	5	17	26	30	10
10	14.5	6	17	26	30	10
12	16.8	7	17	26	29	10
13	18	8	17	26	28	10
14	19.5	8.5	17	27	32	10
17	23.3	9.5	17	29	41	10

RS3450MH/6	6 Pieces Set/Rail 150mm	(g)
8, 10, 12, 13, 14, 17		230

3425 (E)	D <sub>1</sub> (mm)	D <sub>2</sub> (mm)	H (mm)	L (mm)	(g)	(pcs.)
E10(2B)	12	17.3	8.2	26	23	10
E12(2B)	14.5	17.3	9.3	26	25	10
E14(2B)	15.8	17.3	10.6	26	26	10
E16(2B)	18.1	17	11.8	26	27	10
E18(2B)	19.5	18.5	12	32	41	10
E20(2B)	21.9	20	14.4	32	52	10

RS3425/4(2B)	4 Pieces Set/Rail 150mm	(g)
E10, E12, E14, E20		150



## 3450M / 3450A



Nut Grip Sockets **Nut Grip**<sup>®</sup>  
Steckschlüssel mit 2-facher Kugelhalterung  
Douilles à billes de retenue

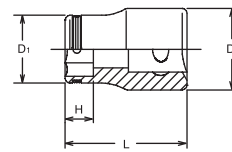

## NUT GRIP<sup>®</sup>

Twin balls at the 6-point opening hold bolt/nut tightly for safe and reliable work.

Die zwei Kugeln in der 6-kant Öffnung unserer NUT GRIP Steckschlüssel halten die Schraube sicher im Steckschlüssel. Dies erlaubt ein Arbeiten auch an schwer zugänglichen Stellen.

Les 2 billes dans l'ouverture du 6-pans de la douille retiennent l'écrou de manière sûre et efficace.

## RS3450M/8 RS3450M/10



Socket Set on Rail  
Steckschlüsselsatz auf Schiene  
Jeu de douilles sur rail



## RS3450A/9



Socket Set on Rail  
Steckschlüsselsatz auf Schiene  
Jeu de douilles sur rail



## 3450MH



Nut Grip Socket wrench with additional hexagon drive  
Nut Grip Steckschlüssel mit zusätzlichem Aussensechskant  
Douilles à deux billes de retenue avec tête hexagonale supplémentaire

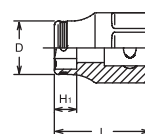

## RS3450MH/6



Socket Set on Rail  
Steckschlüsselsatz auf Schiene  
Jeu de douilles sur rail



## 3425 (2B)



TORX<sup>®</sup> Sockets **Nut Grip**<sup>®</sup>  
TORX Steckschlüssel mit 2-facher Kugelhalterung  
Douilles Torx à deux billes de retenue

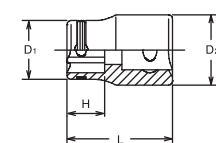

## RS3425/4 (2B)



Socket Set on Rail  
Steckschlüsselsatz auf Schiene  
Jeu de douilles sur rail



**TORX** is a registered trademark of CAMCAR Innovations<sup>®</sup>.  
**TORX** ist ein registriertes Markenzeichen der Firma CAMCAR Innovations<sup>®</sup>.  
**TORX** est une marque déposée de CAMCAR Innovations<sup>®</sup>.

Koken TOOL CO., LTD.

071

Z-SERIES  
HAND  
TITANIUM  
ACCESSORIES  
SCREWDRIVERS  
IMPACT  
SLEEVE-DRIVE  
PROTECTOR  
INDUSTRIAL  
AUTOMOTIVE  
MOTORCYCLE  
CONSTRUCTION  
SPARE PART

## 3300X / 3300XA

6-point Sockets, Semi-Deep  
6-kant Steckschlüssel, mittel-lang  
Douilles, semi-profondes 6-pans

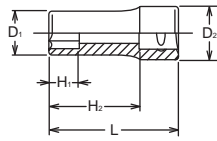

3300X 3305X (mm)	D <sub>1</sub> (mm)	D <sub>2</sub> (mm)	H <sub>1</sub> (mm)	H <sub>2</sub> (mm)	L (mm)	(g)	(pcs.)
8	12	17.3	9	26.5	40	34	10
9	13	17.3	10	26.5	40	36	10
10	14.5	17.3	11	26.5	40	36	10
11	16	17.2	12	26.5	40	36	10
12	16.8	17.2	13	26.5	40	36	10
13	18	17	14	26.5	40	37	10
14	20	18	16	26.5	40	46	10
15	21	20	16	25.5	40	49	10
16	22	20	17	25.5	40	51	10
17	23.5	22	18	25.5	40	61	10
18	24.5	23	19	24.5	40	68	10
19	25	24	20	24.5	40	75	10

## 3305X / 3305XA

12-point Sockets, Semi-Deep  
12-kant Steckschlüssel, mittel-lang  
Douilles, semi-profondes 12-pans

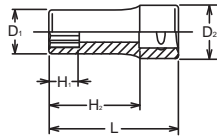
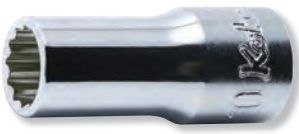

3300XA 3305XA (inch)	D <sub>1</sub> (mm)	D <sub>2</sub> (mm)	H <sub>1</sub> (mm)	H <sub>2</sub> (mm)	L (mm)	(g)	(pcs.)
1/4	10.3	17.3	7	26.5	40	32	10
5/16	12	17.3	9	26.5	40	34	10
3/8	13.9	17.3	11	26.5	40	36	10
7/16	16	17.2	12	26.5	40	36	10
1/2	18	17	14	26.5	40	37	10
9/16	20	18.5	16	26.5	40	46	10
5/8	22	20	17	25.5	40	51	10
11/16	24.5	22.5	19	24.5	40	68	10
3/4	25	23.5	20	24.5	40	75	10

## RS3300X/8 RS3305X/8

Socket Set on Rail  
Steckschlüsselsatz auf Schiene  
Jeu de douilles sur rail



RS3300X/8	8 Pieces Set/Rail 200mm	(g)
8, 10, 11, 12, 13, 14, 17, 19		405

RS3305X/8	8 Pieces Set/Rail 200mm	(g)
8, 10, 11, 12, 13, 14, 17, 19		405

## RS3300XA/9 RS3305XA/9

Socket Set on Rail  
Steckschlüsselsatz auf Schiene  
Jeu de douilles sur rail



RS3300XA/9	9 Pieces Set/Rail 200mm	(g)
1/4, 5/16, 3/8, 7/16, 1/2, 9/16, 5/8, 11/16, 3/4		460

RS3305XA/9	9 Pieces Set/Rail 200mm	(g)
1/4, 5/16, 3/8, 7/16, 1/2, 9/16, 5/8, 11/16, 3/4		460

## 3350X

Nut Grip Socket, Semi-Deep **Nut Grip**®  
Steckschlüssel mit 2-facher Kugelhalterung, mittel-lang  
Douilles à billes de retenue, semi-profondes

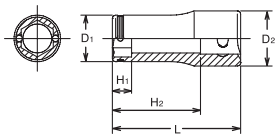

3350X (mm)	D <sub>1</sub> (mm)	D <sub>2</sub> (mm)	H <sub>1</sub> (mm)	H <sub>2</sub> (mm)	L (mm)	(g)	(pcs.)
8	12	17.4	5	26.5	40	33	10
10	14.5	17.4	6	26.5	40	35	10
12	16.8	17.2	7	26.5	40	40	10
13	18	17	8	26.5	40	45	10
14	19.5	18.5	8.5	26.5	40	48	10

## RS3350X/4

Socket Set on Rail  
Steckschlüsselsatz auf Schiene  
Jeu de douilles sur rail



RS3350X/4	4 Pieces Set/Rail 150mm	(g)
8, 10, 12, 14		165

3300M 3305M (mm)	D <sub>1</sub> (mm)	D <sub>2</sub> (mm)	H <sub>1</sub> (mm)	H <sub>2</sub> (mm)	L (mm)	(g)	(pcs.)
5.5	8.9	17.3	6.5	41.5	55	37	10
6	9.9	17.3	7	41.5	55	37	10
7	10.6	17.3	8	41.5	55	37	10
8	12	17.3	9	41.5	55	40	10
9	13	17.3	10	41.5	55	42	10
10	14.5	17.3	11	41.5	55	46	10
11	16	17.2	12	41.5	55	51	10
12	16.8	17.2	13	41.5	55	52	10
13	18	17	14	41.5	55	53	10
14	20	18	16	41.5	55	60	10
15	21	20	16	40.5	55	74	10
16	22	20	17	40.5	55	76	10
17	23.5	22	18	40.5	55	93	10
18	24.5	23	19	39.5	55	98	10
19	25	24	20	39.5	55	98	10
20	26	25	21	49.5	65	126	10
21	27	26	22	49.5	65	126	10
22	29	28	23	48.5	65	163	10
23	30	29	24	48.5	65	168	10
24	31	30	25	47.5	65	191	10
25	33	30	26	47.5	65	199	10
26	34	31	27	47.5	65	209	10
27	35	32.5	28	47.5	65	218	10

## 3300M / 3300A

6-point Deep Sockets  
6-kant-Steckschlüssel, lang  
Douilles longues 6-pans

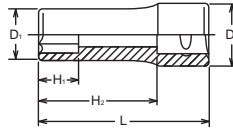

3300A 3305A (inch)	D <sub>1</sub> (mm)	D <sub>2</sub> (mm)	H <sub>1</sub> (mm)	H <sub>2</sub> (mm)	L (mm)	(g)	(pcs.)
3/16	8.3	17.3	6	41.5	55	35	10
7/32	8.9	17.3	6.5	41.5	55	35	10
1/4	9.9	17.3	7	41.5	55	37	10
5/16	12	17.3	9	41.5	55	40	10
11/32	12.3	17.3	10	41.5	55	41	10
3/8	14	17.3	11	41.5	55	46	10
7/16	16	17.2	12	41.5	55	51	10
1/2	18	17	14	41.5	55	53	10
9/16	20	18	16	41.5	55	60	10
19/32	21	20	16	40.5	55	74	10
5/8	22	20	17	40.5	55	76	10
11/16	23.5	22	18	40.5	55	93	10
3/4	25	24	20	39.5	55	98	10
13/16	27	26	22	49.5	65	126	10
7/8	29	28	23	48.5	65	163	10
15/16	31	30	25	47.5	65	191	10

## 3305M / 3305A

12-point Deep Sockets  
12-kant Steckschlüssel, lang  
Douilles longues, 12-pans

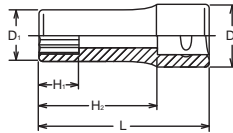

RS3300M/12	12 Pieces Set/Rail 300mm	(g)
8, 9, 10, 11, 12, 13, 14, 15, 16, 17, 18, 19		878

RS3305M/12	12 Pieces Set/Rail 300mm	(g)
8, 9, 10, 11, 12, 13, 14, 15, 16, 17, 18, 19		878

## RS3300M/12

Socket Set on Rail  
Steckschlüsselsatz auf Schiene  
Jeu de douilles sur rail

## RS3305M/12



RS3300A/9	9 Pieces Set/Rail 200mm	(g)
1/4, 5/16, 3/8, 7/16, 1/2, 9/16, 5/8, 11/16, 3/4		628

RS3305A/9	9 Pieces Set/Rail 200mm	(g)
1/4, 5/16, 3/8, 7/16, 1/2, 9/16, 5/8, 11/16, 3/4		628

## RS3300A/9

Socket Set on Rail  
Steckschlüsselsatz auf Schiene  
Jeu de douilles sur rail

## RS3305A/9



# Hand Sockets Hand Steckschlüssel Douilles à main

# 3/8"

Z-SERIES  
HAND  
TITANIUM  
SCREWDRIVERS ACCESSORIES  
IMPACT  
SLEEVE-DRIVE  
PROTECTOR  
INDUSTRIAL  
AUTOMOTIVE  
MOTORCYCLE  
CONSTRUCTION  
SPARE PART

## 3310M

Surface Drive Deep Sockets  
Surface Drive Steckschlüssel, lang  
Douilles longues, Surface Drive

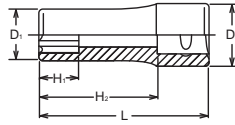

3310M (mm)	D <sub>1</sub> (mm)	D <sub>2</sub> (mm)	H <sub>1</sub> (mm)	H <sub>2</sub> (mm)	L (mm)	(g)	(pcs.)
6	9.9	17.3	7	41.5	55	37	10
7	10.6	17.3	8	41.5	55	37	10
8	12	17.3	9	41.5	55	40	10
9	13	17.3	10	41.5	55	42	10
10	14.5	17.3	11	41.5	55	46	10
11	16	17.2	12	41.5	55	51	10
12	16.8	17.2	13	41.5	55	52	10
13	18	17	14	41.5	55	53	10
14	20	18	16	41.5	55	60	10
15	21	20	16	40.5	55	74	10
16	22	20	17	40.5	55	76	10
17	23.5	22	18	40.5	55	93	10
18	24.5	23	19	39.5	55	98	10
19	25	24	20	39.5	55	98	10
20	26	25	21	49.5	65	126	10
21	27	26	22	49.5	65	126	10
22	29	28	23	48.5	65	163	10
23	30	29	24	48.5	65	168	10
24	31	30	25	47.5	65	161	10

## RS3310M/12

Socket Set on Rail  
Steckschlüsselsatz auf Schiene  
Jeu de douilles sur rail



RS3310M/12	12 Pieces Set/Rail 300mm	(g)
8, 9, 10, 11, 12, 13, 14, 15, 16, 17, 18, 19		881

## 3300W

6-point Deep Whitworth Sockets  
6-kant Steckschlüssel, lang, Whitworth  
Douilles longues à 6-pans Whitworth

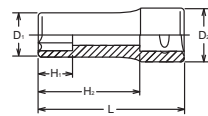

3300W 3305W (W)	D <sub>1</sub> (mm)	D <sub>2</sub> (mm)	H <sub>1</sub> (mm)	H <sub>2</sub> (mm)	L (mm)	(g)	(pcs.)
1/8	12.3	17.3	10	41.5	55	46	10
3/16	16	17.3	12	41.5	55	55	10
1/4	18	17	14	41.5	55	57	10
5/16	21	20	16	40.5	55	79	10
3/8	24.5	23	19	39.5	55	96	10
7/16	27	26	22	49.5	65	140	10
1/2	30	29	24	48.5	65	193	10
9/16	34	31	27	47.5	65	250	10

## 3305W

12-point Deep Whitworth Sockets  
12-kant Steckschlüssel, Whitworth  
Douilles longues à 12-pans Whitworth

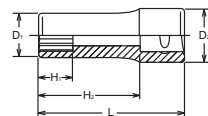

## RS3300W/7 RS3305W/7

Socket Set on Rail  
Steckschlüsselsatz auf Schiene  
Jeu de douilles sur rail



RS3300W/7	7 Pieces Set/Rail 200mm	(g)
1/8, 3/16, 1/4, 5/16, 3/8, 7/16, 1/2		719

RS3305W/7	7 Pieces Set/Rail 200mm	(g)
1/8, 3/16, 1/4, 5/16, 3/8, 7/16, 1/2		719

### BS W



BS-W	BS	3/16BS	1/4BS	5/16BS	3/8BS	7/16BS	1/2BS	9/16BS	5/8BS	11/16BS	3/4BS	7/8BS
	W	1/8W	3/16W	1/4W	5/16W	3/8W	7/16W	1/2W	9/16W	5/8W	11/16W	3/4W
S	(ref. mm)	8.64	11.30	13.34	15.24	18.03	20.83	23.37	25.65	27.94	30.48	33.35

# Hand Sockets Hand Steckschlüssel Douilles à main

3325 (E)	D <sub>1</sub> (mm)	D <sub>2</sub> (mm)	H <sub>1</sub> (mm)	H <sub>2</sub> (mm)	L (mm)	(g)	(pcs.)
E 4	5.6	17.3	4.6	41.5	55	29	10
E 5	6.9	17.3	5.2	41.5	55	31	10
E 6	7.9	17.3	5.4	41.5	55	33	10
E 7	8.9	17.3	6.6	41.5	55	36	10
E 8	9.9	17.3	7	41.5	55	39	10
E10	11.8	17.3	8.2	41.5	55	43	10
E11	13	17.3	8.7	41.5	55	50	10
E12	14.5	17.2	9.3	41.5	55	53	10
E14	15.7	17.2	10.6	41.5	55	57	10
E16	18	17	11.8	41.5	55	69	10

RS3325/9	9 Pieces Set/Rail 200mm	(g)
E4, E5, E6, E7, E8, E10, E12, E14, E16		420

**3325** TORX® Deep Sockets  
TORX® Steckschlüssel, lang  
Douilles longues TORX®

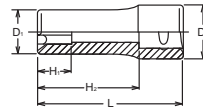

**RS3325/9** Socket Set on Rail  
Steckschlüsselsatz auf Schiene  
Jeu de douilles sur rail



TORX®  
(E)

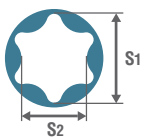

E	E4	E5	E6	E7	E8	E10	E11	E12	E14	E16	E18	E20	E22	E24	E26	E28	E30	E32
S <sub>1</sub> (ref. mm)	3.7	4.6	5.6	6.1	7.4	9.3	9.9	11.0	12.8	14.6	16.5	18.3	20.1	22.0	23.7	25.5	27.3	29.0
S <sub>2</sub> (ref. mm)	2.7	3.3	4.0	4.3	5.3	6.8	7.1	7.9	9.2	10.5	11.9	13.2	14.8	15.7	17.5	18.3	20.0	21.3

3350M (mm)	D <sub>1</sub> (mm)	D <sub>2</sub> (mm)	H <sub>1</sub> (mm)	H <sub>2</sub> (mm)	L (mm)	(g)	(pcs.)
8	12	17.4	5	41.5	55	50	10
10	14.5	17.4	6	41.5	55	54	10
12	16.8	17.2	7	41.5	55	58	10
13	18	17	8	41.5	55	59	10
14	19.5	18.5	8.5	41.5	55	71	10



RS3350M/5	5 Pieces set/Rail 150mm	(g)
8, 10, 12, 13, 14		322

**3350M** Nut Grip Deep Sockets **Nut Grip®**  
Steckschlüssel mit 2-facher Kugelhalterung, lang  
Douilles longues à double billes de retenue

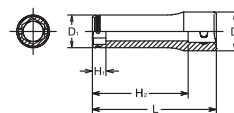

**RS3350M/5** Socket Set on Rail  
Steckschlüsselsatz auf Schiene  
Jeu de douilles sur rail



3300FN (mm)	D <sub>1</sub> (mm)	D <sub>2</sub> (mm)	H (mm)	L (mm)	S (mm)	(g)	(pcs.)
8	14.5	17.3	6	53	6.4	38	10
9	16	17.3	7	53	6.8	41	10
10	16.8	17.2	7.5	53	7.2	42	10
11	18	17	8.5	53	8.3	42	10
12	20	18	9	53	8.8	50	10
13	21.1	20	9.5	62	9.4	66	10
14	22	20	10.5	62	10.5	66	10
15	23	22	11	70	11.5	82	10
16	24	23	11.5	70	12	90	10
17	25	24	12.5	80	13	110	10
18	27	25	13	80	13.5	120	10
19	28	26	14	80	14.5	130	10
21	30	27.5	15	80	15.5	170	10
22	32	29.5	16	80	16	180	10
24	34.5	31.5	17	80	17	200	10

RS3300FN/8	8 Pieces Set/Rail 200mm	(g)
9, 10, 11, 13, 14, 16, 17, 19		600

**3300FN** Flare Nut Sockets  
Geschlitzte Steckschlüssel für Überwurfmutter  
Douilles à tuyauter

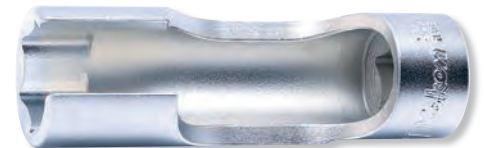
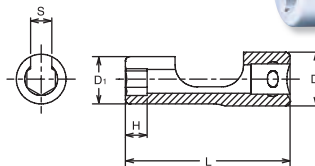

**RS3300FN/8** Socket Set on Rail  
Steckschlüsselsatz auf Schiene  
Jeu de douilles sur rail



Z-SERIES  
HAND  
TITANIUM  
SCREWDRIVERS ACCESSORIES  
IMPACT  
SLEEVE-DRIVE  
PROTECTOR  
INDUSTRIAL  
AUTOMOTIVE  
MOTORCYCLE  
CONSTRUCTION  
SPARE PART

### 3300M (L120)

6-point Extra Deep Sockets  
6-kant Steckschlüssel, extra lang  
Douilles extra longues 6-pans



### 3305M (L120)

12-point Extra Deep Sockets  
12-kant Steckschlüssel, extra lang  
Douilles extra longues 12-pans

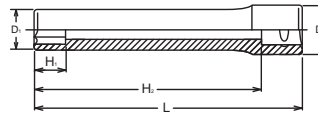

3300M-Size DEEP SOCKET

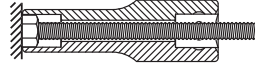

3300M-Size(L120) EXTRA DEEP SOCKET

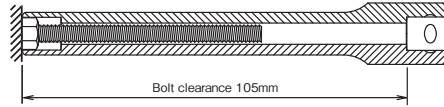

3300M(L120) 3305M(L120) (mm)	D <sub>1</sub> (mm)	D <sub>2</sub> (mm)	H <sub>1</sub> (mm)	H <sub>2</sub> (mm)	L (mm)	(g)	(pcs.)
8	12	17.3	9	106.5	120	85	10
10	14.5	17.3	11	106.5	120	110	10
12	16.8	17.2	13	106.5	120	116	10
13	18	17	14	106.5	120	155	5
14	20	18	16	106.5	120	166	5

### 3300M/4-L120 3305M/4-L120

Socket Set  
Steckschlüssel Satz  
Jeu de clés à douille



3300M/4-L120 4 Pieces Set/△=477g

PLASTIC BAG

Sockets

3300M(L120) 6-point Extra Deep Sockets  
8, 10, 12, 14

3305M/4-L120 4 Pieces Set/△=477g

PLASTIC BAG

Sockets

3305M(L120) 12-point Extra Deep Sockets  
8, 10, 12, 14

### 3350M (L120) / 3350A (L120)

Nut Grip Deep Sockets **Nut Grip**<sup>®</sup>  
Steckschlüssel mit 2-facher Kugelhalterung, lang  
Douilles extra longues à double billes de retenue

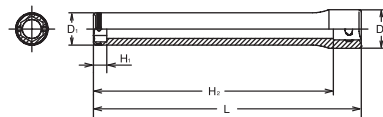

3350M(L120) (mm)	D <sub>1</sub> (mm)	D <sub>2</sub> (mm)	H <sub>1</sub> (mm)	H <sub>2</sub> (mm)	L (mm)	(g)	(pcs.)
8	12	17.3	5	106.5	120	77	10
10	14.5	17.2	6	106.5	120	110	10
12	16.8	17.2	7	106.5	120	116	10

3350A(L120) (inch)	D <sub>1</sub> (mm)	D <sub>2</sub> (mm)	H <sub>1</sub> (mm)	H <sub>2</sub> (mm)	L (mm)	(g)	(pcs.)
7/16	15.8	17.3	6.5	106.5	120	123	10
1/2	18	17	8	106.5	120	142	10
9/16	20	18.5	8.5	106.5	120	179	10



NUT GRIP<sup>®</sup>

### 3350M/2-L120

Socket Set  
Steckschlüssel Satz  
Jeu de clés à douille

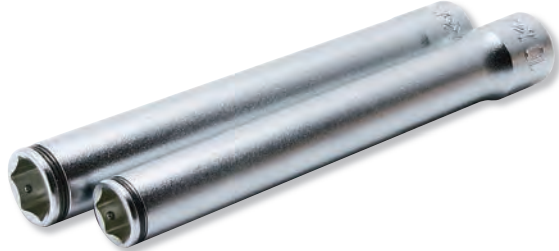

3350M/2-L120 2 Pieces Set/△=230g

PLASTIC BAG

Sockets

3350M(L120) Nut Grip Extra Deep Sockets  
10, 12

3440M 3445M (mm)	D <sub>1</sub> (mm)	D <sub>2</sub> (mm)	H (mm)	L (mm)	(g)	(pcs.)
8	12	19	7.3	47	50	10
9	13.3	19	7.8	47.5	50	10
10	14.5	19	8.8	48.5	64	10
11	15.8	19	9.8	49.5	66	10
12	17	19	10.3	50	67	10
13	18.3	19	11.3	51	68	10
14	19.5	19	11.3	51	69	10
15	20.8	19	12.8	53.5	70	10
16	22	19	12.8	53.5	77	10
17	23.3	19	13.8	54.5	80	10
18	24.5	19	13.8	54.5	80	10
19	25.8	19	15.8	56.5	84	10
21	28.3	19	16.8	56.5	96	10

3440A 3445A (inch)	D <sub>1</sub> (mm)	D <sub>2</sub> (mm)	H (mm)	L (mm)	(g)	(pcs.)
5/16	12	19	7.3	47	50	10
3/8	14	19	8.3	48	64	10
7/16	15.8	19	9.8	49.5	66	10
1/2	18.3	19	11.3	51	68	10
9/16	19.5	19	11.3	51	69	10
5/8	22	19	12.8	53.5	77	10
11/16	24.5	19	13.8	54.5	80	10
3/4	25.8	19	15.8	56.5	84	10

RS3440M/8	8 Pieces Set/Rail 200mm	(g)
8, 10, 11, 12, 13, 14, 17, 19		550

RS3440A/8	8 Pieces Set/Rail 200mm	(g)
5/16, 3/8, 7/16, 1/2, 9/16, 5/8, 11/16, 3/4		570

3445W (W)	D <sub>1</sub> (mm)	D <sub>2</sub> (mm)	H (mm)	L (mm)	(g)	(pcs.)
1/8	13.3	19	7.8	47.5	50	10
3/16	15.8	19	9.7	49.5	66	10
1/4	18.3	19	11.3	51	68	10
5/16	20.8	19	12.8	53.5	70	10
3/8	24.5	19	13.8	54.5	80	10
7/16	28.3	19	16.8	57.5	96	10
1/2	30.8	19	17.8	58.5	105	10

RS3445W/7	7 Pieces Set/Rail 200mm	(g)
1/8, 3/16, 1/4, 5/16, 3/8, 7/16, 1/2		570

3440T (E)	D <sub>1</sub> (mm)	D <sub>2</sub> (mm)	H (mm)	L (mm)	(g)	(pcs.)
E 6	7.9	19	5.4	44.9	60	10
E 8	9.9	19	7	46.5	63	10
E10	11.8	19	8.2	47.7	63	10
E12	14.5	19	9.3	48.8	68	10
E14	15.7	19	10.6	50.1	68	10
E16	18	19	11.8	51.3	70	10
E18	19.5	19	13	53.5	78	10
E20	22	19	14.4	54.9	81	10

## 3440M / 3440A

6-point Universal Sockets  
6-kant Gelenk-Einsätze  
Douilles articulées, 6-pans

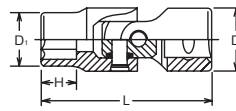

## 3445M / 3445A

12-point Universal Sockets  
12-kant Gelenk-Einsätze  
Douilles articulées, 12-pans

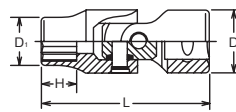

## RS3440M/8

Socket Set on Rail  
Steckschlüsselsatz auf Schiene  
Jeu de douilles sur rail

## RS3440A/8



## 3445W

12-Point Whitworth Universal Socket  
12-kant Gelenk-Einsatz, Whitworth  
Douilles articulées 12-pans, Witworth

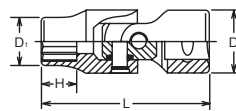

## RS3445W/7

Socket Set on Rail  
Steckschlüsselsatz auf Schiene  
Jeu de douilles sur rail



## 3440T

TORX® Universal Sockets  
TORX® Gelenk-Einsätze  
Douilles articulées TORX®

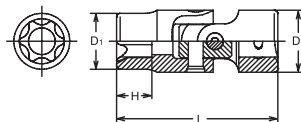

Z-SERIES  
HAND  
TITANIUM  
SCREWDRIVERS ACCESSORIES  
IMPACT  
SLEEVE-DRIVE  
PROTECTOR  
INDUSTRIAL  
AUTOMOTIVE  
MOTORCYCLE  
CONSTRUCTION  
SPARE PART

## RS3440T/8



Socket Set on Rail  
Steckschlüsselsatz auf Schiene  
Jeu de douilles sur rail



RS3440T/8	8 Pieces Set/Rail 200mm	(g)
E6, E8, E10, E12, E14, E16, E18, E20		594

TORX®  
(E)

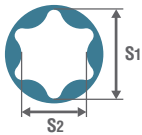

E	E4	E5	E6	E7	E8	E10	E11	E12	E14	E16	E18	E20	E22	E24	E26	E28	E30	E32
S <sub>1</sub> (ref. mm)	3.7	4.6	5.6	6.1	7.4	9.3	9.9	11.0	12.8	14.6	16.5	18.3	20.1	22.0	23.7	25.5	27.3	29.0
S <sub>2</sub> (ref. mm)	2.7	3.3	4.0	4.3	5.3	6.8	7.1	7.9	9.2	10.5	11.9	13.2	14.8	15.7	17.5	18.3	20.0	21.3

## 3441M



Nut Grip Universal Sockets **Nut Grip**®  
Gelenk-Einsätze mit zweifacher Kugelhalterung  
Douilles articulées, à double billes de retenue

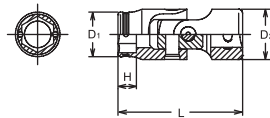

3441M (mm)	D <sub>1</sub> (mm)	D <sub>2</sub> (mm)	H (mm)	L (mm)	(g)	(pcs.)
8	12	19	5	46	57	10
10	14.5	19	6	46	58	10
11	15.8	19	6.5	46.5	61	10
12	16.8	19	7	47	58	10
13	18	19	8	48	60	10
14	19.5	19	8.5	49.5	65	10
15	21	19	9	50	69	10
16	22	19	9	50	70	10
17	23.5	19	9.5	51	73	10
18	24.6	19	10.5	51.5	76	10
19	26	19	11.5	52.5	80	10



## RS3441M/11



Socket Set on Rail  
Steckschlüsselsatz auf Schiene  
Jeu de douilles sur rail



RS3441M/11	11 Pieces Set/Rail 300mm	(g)
8, 10, 11, 12, 13, 14, 15, 16, 17, 18, 19		750

## 3340M-75



Universal Deep Sockets  
Gelenk-Steckschlüssel, lange Ausführung  
Douilles articulées longues

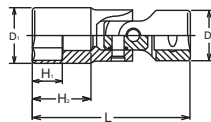

3340M-75 (mm)	D <sub>1</sub> (mm)	D <sub>2</sub> (mm)	H <sub>1</sub> (mm)	H <sub>2</sub> (mm)	L (mm)	(g)	(pcs.)
8	12	19	9	39	75	82	10
10	14.5	19	11	39	75	87	10
11	15.8	19	12	39	75	87	10
12	17	19	13	39	75	92	10
13	18.3	19	14	36	75	93	10
14	19.5	19	15	35	75	103	10
15	20.8	19	16	35	75	104	10
16	22	19	17	34	75	110	10
17	23.3	19	18	34	75	115	10
18	24.5	19	19	34	75	119	10
19	25.8	19	20	33	75	123	10

## RS3340M/8-L75



Socket Set on Rail  
Steckschlüsselsatz auf Schiene  
Jeu de douilles sur rail



RS3340M/8-L75	8 Pieces Set/Rail 200mm	(g)
8, 10, 11, 12, 13, 14, 17, 19		810

3430M (mm)	D (mm)	H (mm)	L (mm)	(g)	(pcs.)
5	19	15.5	62	66	10
6	19	15.5	62	70	10
7	19	15.5	62	72	10
8	19	15.5	62	74	10
10	19	15.5	62	78	10
12	19	15.5	62	85	10

## 3430M Universal Hex Sockets Gelenk-Einsätze für Schrauben mit Innensechskant Douilles articulées, 6-pans mâle

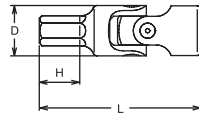

RS3430M/6	6 Pieces Set/Rail 150mm	(g)
5, 6, 7, 8, 10, 12		470

## RS3430M/6 Socket Set on Rail Steckschlüsselsatz auf Schiene Jeu de douilles sur rail



## 3117M-125 / -250 Extended Sockets Schaftsteckschlüssel Douilles rallongées

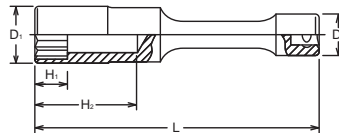

3117M-125 (mm)	D <sub>1</sub> (mm)	D <sub>2</sub> (mm)	H <sub>1</sub> (mm)	H <sub>2</sub> (mm)	L (mm)	(g)	(pce.)
10	14.5	18	10	44	125	121	1
12	17	18	12	44	125	133	1
13	18	18	13	44	125	134	1
14	19.5	18	14	44	125	145	1
17	23.5	18	17	44	125	178	1
19	25	18	19	44	125	187	1

3117M-250 (mm)	D <sub>1</sub> (mm)	D <sub>2</sub> (mm)	H <sub>1</sub> (mm)	H <sub>2</sub> (mm)	L (mm)	(g)	(pce.)
10	14.5	18	10	44	250	233	1
12	17	18	12	44	250	246	1
13	18	18	13	44	250	249	1
14	19.5	18	14	44	250	262	1
17	23.5	18	17	44	250	289	1
19	25	18	19	44	250	298	1

Z-SERIES  
HAND  
TITANIUM  
SCREWDRIVERS ACCESSORIES  
IMPACT  
SLEEVE-DRIVE  
PROTECTOR  
INDUSTRIAL  
AUTOMOTIVE  
MOTORCYCLE  
CONSTRUCTION  
SPARE PART

## 3000-60 (PH)

 PH Bit Sockets  
Steckschlüssel für Kreuzschlitzschrauben, PH  
Douilles tournevis pour vis à empreinte PH

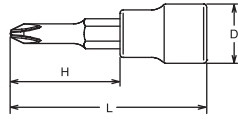

3000 (PH)	D (mm)	H (mm)	L (mm)	(g)	(pcs.)
1	18	33.5	60	49	10
2	18	33.5	60	49	10
3	18	33.5	60	49	10
4	18	33.5	60	50	10

## 3000-50 (PZ)

 PZ Bit Sockets  
Steckschlüssel für Kreuzschlitzschrauben, PZ  
Douilles tournevis pour vis à empreinte PZ

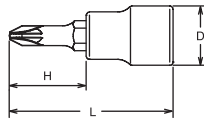







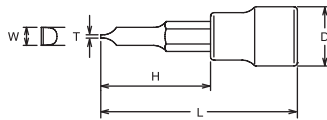

3000-50 (PZ)	D (mm)	H (mm)	L (mm)	(g)	(pcs.)
PZ1	18	23.5	50	50	10
PZ2	18	23.5	50	50	10
PZ3	18	23.5	50	50	10

## 3005-60



 Bit Sockets for Slotted Heads  
Steckschlüssel für Schlitzschrauben  
Douilles tournevis pour vis à fente



3005	TxW (mm)	D (mm)	H (mm)	L (mm)	(g)	(pcs.)
5	1.0x 5.5	18	33.5	60	47	10
8	1.2x 8	18	33.5	60	49	10
10	1.6x10	20	33.5	60	85	10

	 PH	 PZ	 Slotted	 HEX	 HEX (ball point)	 Triple Square (XZN)	 TORX® (T)	 TORX® (TH)	 TORXPLUS® (IP)	 TORXPLUS® (IPR)	 Ribe-CV
1/4"	No.2000 series	No.2000(PZ) series	No.2005 series	No.2010M/A series	No.2011M series	No.2020 series	No.2025 series	No.2025(TH) series	No.2025(IP) series	No.2025(IPR) series	—
3/8"	No.3000 series	No.3000(PZ) series	No.3005 series	No.3010M/A No.3012M/A No.3015M series	No.3011M series	No.3020 series	No.3025 series	No.3025(TH) series	No.3025(IP) series	No.3025(IPR) series	No.3027 series
1/2"	No.4000 series	No.4000(PZ) series	No.4005 series	No.4010M/A No.4012M/A series	—	No.4020 series	No.4025 series	—	No.4025(IP) series	—	No.4027 series

## 3010M-38 / -62 / -100 / -160 3010A-50

 Inhex Bit Sockets  
Steckschlüssel für Innensechskant-Schrauben  
 Douilles tournevis pour vis 6-pans creux

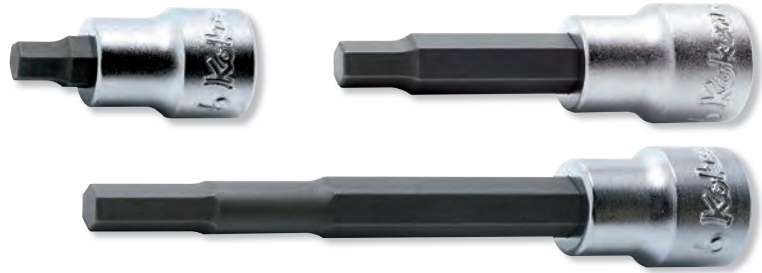
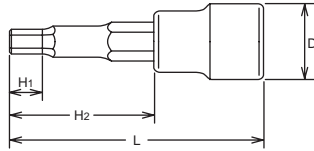

3010M-38 (mm)	D (mm)	H <sub>1</sub> (mm)	H <sub>2</sub> (mm)	L (mm)	(g)	(pcs.)
3	18	5	11.5	38	27	10
4	18	5	11.5	38	28	10
5	18	5	11.5	38	30	10
6	18	6	11.5	38	31	10
7	18	7	11.5	38	32	10
8	18	-	11.5	38	33	10
9	20	8	11.5	38	47	10
10	20	-	11.5	38	48	10
11	20	8	11.5	38	59	10
12	20	-	11.5	38	60	10
13	22	-	11.5	38	76	5
14	22	-	11.5	38	78	5

3010M-100 (mm)	D (mm)	H <sub>1</sub> (mm)	H <sub>2</sub> (mm)	L (mm)	(g)	(pcs.)
3	18	15.5	73.5	100	58	10
4	18	15.5	73.5	100	60	10
5	18	15.5	73.5	100	63	10
6	18	15.5	73.5	100	64	10
7	18	15.5	73.5	100	66	10
8	18	-	73.5	100	69	10
9	20	15.5	73.5	100	100	10
10	20	-	73.5	100	102	10
11	20	15.5	73.5	100	129	10
12	20	-	73.5	100	131	10
13	22	15.5	73.5	100	158	5
14	22	-	73.5	100	160	5

3010M-62 (mm)	D (mm)	H <sub>1</sub> (mm)	H <sub>2</sub> (mm)	L (mm)	(g)	(pcs.)
3	18	8.5	35.5	62	43	10
4	18	8.5	35.5	62	45	10
5	18	8.5	35.5	62	48	10
6	18	8.5	35.5	62	49	10
7	18	8.5	35.5	62	50	10
8	18	-	35.5	62	62	10
9	20	8.5	35.5	62	75	10
10	20	-	35.5	62	76	10
11	20	8.5	35.5	62	92	10
12	20	-	35.5	62	94	10
13	22	8.5	35.5	62	107	5
14	22	-	35.5	62	109	5

3010M-160 (mm)	D (mm)	H <sub>1</sub> (mm)	H <sub>2</sub> (mm)	L (mm)	(g)	(pcs.)
3	18	15.5	133.5	160	84	10
4	18	15.5	133.5	160	86	10
5	18	15.5	133.5	160	89	10
6	18	15.5	133.5	160	90	10
7	18	15.5	133.5	160	92	10
8	18	-	133.5	160	95	10
9	20	15.5	133.5	160	125	10
10	20	-	133.5	160	128	10
11	20	15.5	133.5	160	153	10
12	20	-	133.5	160	157	10
13	22	15.5	133.5	160	237	5
14	22	-	133.5	160	239	5

3010A-50 (inch)	D (mm)	H <sub>1</sub> (mm)	H <sub>2</sub> (mm)	L (mm)	(g)	(pcs.)
1/8	18	8.5	23.5	50	35	10
5/32	18	8.5	23.5	50	36	10
3/16	18	8.5	23.5	50	36	10
7/32	18	8.5	23.5	50	38	10
1/4	18	8.5	23.5	50	40	10
9/32	18	8.5	23.5	50	42	10
5/16	18	-	23.5	50	44	10
11/32	20	8.5	23.5	50	59	10
3/8	20	8.5	23.5	50	60	10
7/16	20	8.5	23.5	50	74	10
1/2	22	8.5	23.5	50	91	5

RS3010M/8-L38	8 Pieces Set/Rail 200mm	(g)
3, 4, 5, 6, 7, 8, 10, 12		322
RS3010M/8-L62	8 Pieces Set/Rail 200mm	(g)
3, 4, 5, 6, 7, 8, 10, 12		490
RS3010M/8-L100	8 Pieces Set/Rail 200mm	(g)
3, 4, 5, 6, 7, 8, 10, 12		645
RS3010A/8-L50	8 Pieces Set/Rail 200mm	(g)
1/8, 5/32, 3/16, 7/32, 1/4, 5/16, 3/8, 1/2		400

### RS3010M/8-L38



Socket Set on Rail  
Steckschlüsselsatz auf Schiene  
Jeu de douilles sur rail

### RS3010M/8-L62



### RS3010M/8-L100



### RS3010A/8-L50



## 3012M-25

 Inhex Sockets  
Steckschlüssel für Innensechskant-Schrauben  
Douilles tournevis pour vis 6-pans creux

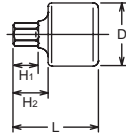

3012M-25 (mm)	D (mm)	H <sub>1</sub> (mm)	H <sub>2</sub> (mm)	L (mm)	(g)	(pcs.)
3	18.5	5.5	10	25	22	10
4	18.5	5.5	10	25	22	10
5	18.5	6.5	10	25	22	10
6	18.5	7.5	10	25	23	10
7	18.5	10	-	25	24	10
8	18.5	10	-	25	25	10
10	18.5	10	-	25	27	10
12	18.5	10	-	25	30	10
14	19	10	-	25	30	10
17	19	10	-	25	30	10

## 3012M-52 / -62 / -75 3012A-52 / -62 / -75

 Inhex Sockets  
Steckschlüssel für Innensechskant-Schrauben  
Douilles tournevis pour vis 6-pans creux



For Lubrication Service  
Schmierdienst-Werkzeuge  
Service lubrification-vidange

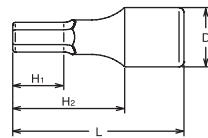

3012M/A are for hand use only.  
Do not use with a power or impact wrench.  
Bitte nicht auf Schlagschrauber oder anderen  
Maschinen gebrauchen.  
À ne pas utiliser sur des machines

3012M-52 (mm)	D (mm)	H <sub>1</sub> (mm)	H <sub>2</sub> (mm)	L (mm)	(g)	(pcs.)
3	18	10	34	52	35	10
4	18	15.5	34	52	38	10
5	18	15.5	34	52	40	10
6	18	15.5	34	52	42	10
7	18	15.5	34	52	46	10
8	18.5	15.5	34	52	50	10
9	18.5	15.5	34	52	55	10
10	20	15.5	34	52	66	10
11	20	15.5	34	52	72	10
12	20	15.5	34	52	77	10
13	20	15.5	34	52	82	10
14	20	15.5	34	52	89	10

3012M-62 (mm)	D (mm)	H <sub>1</sub> (mm)	H <sub>2</sub> (mm)	L (mm)	(g)	(pcs.)
3	18	10	44	62	38	10
4	18	15.5	44	62	40	10
5	18	15.5	44	62	43	10
6	18	15.5	44	62	46	10
7	18	15.5	44	62	53	10
8	18.5	15.5	44	62	58	10
9	18.5	15.5	44	62	63	10
10	20	15.5	44	62	77	10
11	20	15.5	44	62	83	10
12	20	15.5	44	62	90	10
13	20	15.5	44	62	95	10
14	20	15.5	44	62	109	10

3012M-75 (mm)	D (mm)	H <sub>1</sub> (mm)	H <sub>2</sub> (mm)	L (mm)	(g)	(pcs.)
3	18	10	57	75	41	10
4	18	15.5	57	75	43	10
5	18	15.5	57	75	48	10
6	18	15.5	57	75	53	10
7	18	15.5	57	75	58	10
8	18.5	15.5	57	75	72	10
9	18.5	15.5	57	75	92	10
10	20	15.5	57	75	114	10
11	20	15.5	57	75	120	10
12	20	15.5	57	75	127	10
13	20	15.5	57	75	132	10
14	20	15.5	57	75	146	10

3012A-52 (inch)	D (mm)	H <sub>1</sub> (mm)	H <sub>2</sub> (mm)	L (mm)	(g)	(pcs.)
1/8	18	10	34	52	35	10
5/32	18	15.5	34	52	38	10
3/16	18	15.5	34	52	40	10
7/32	18	15.5	34	52	42	10
1/4	18	15.5	34	52	44	10
9/32	18	15.5	34	52	46	10
5/16	18.5	15.5	34	52	50	10
11/32	18.5	15.5	34	52	55	10
3/8	20	15.5	34	52	65	10
7/16	20	15.5	34	52	72	10
1/2	20	15.5	34	52	82	10
9/16	20	15.5	34	52	89	10

3012A-62 (inch)	D (mm)	H <sub>1</sub> (mm)	H <sub>2</sub> (mm)	L (mm)	(g)	(pcs.)
1/8	18	10	44	62	38	10
5/32	18	15.5	44	62	40	10
3/16	18	15.5	44	62	43	10
7/32	18	15.5	44	62	46	10
1/4	18	15.5	44	62	48	10
9/32	18	15.5	44	62	53	10
5/16	18.5	15.5	44	62	58	10
11/32	18.5	15.5	44	62	63	10
3/8	20	15.5	44	62	73	10
7/16	20	15.5	44	62	83	10
1/2	20	15.5	44	62	95	10
9/16	20	15.5	44	62	109	10

3012A-75 (inch)	D (mm)	H <sub>1</sub> (mm)	H <sub>2</sub> (mm)	L (mm)	(g)	(pcs.)
1/8	18	10	57	75	41	10
5/32	18	15.5	57	75	43	10
3/16	18	15.5	57	75	48	10
7/32	18	15.5	57	75	53	10
1/4	18	15.5	57	75	53	10
9/32	18	15.5	57	75	58	10
5/16	18.5	15.5	57	75	72	10
11/32	18.5	15.5	57	75	92	10
3/8	20	15.5	57	75	110	10
7/16	20	15.5	57	75	120	10
1/2	20	15.5	57	75	132	10
9/16	20	15.5	57	75	146	10

## RS3012M/8-L52 RS3012A /8-L52



 Socket Set on Rail  
Steckschlüsselsatz auf Schiene  
Jeu de douilles sur rail



RS3012M/8-L52	8 Pieces Set/Rail 200mm	(g)
3, 4, 5, 6, 7, 8, 10, 12		394

RS3012A/8-L52	8 Pieces Set/Rail 200mm	(g)
1/8, 5/32, 3/16, 7/32, 1/4, 5/16, 3/8, 1/2		425

## 3011M-62 / -100 / -120 / -160

 Ballpoint Inhex Sockets  
Steckschlüssel mit Kugelkopf, für Innensechskant-Schrauben   
Douilles tournevis avec tête sphérique pour vis 6-pans creux

3011M-62 (mm)	D (mm)	H (mm)	L (mm)	(g)	(pcs.)
3	18	35.5	62	45	10
4	18	35.5	62	46	10
5	18	35.5	62	48	10
6	18	35.5	62	49	10
7	18	35.5	62	50	10
8	18	35.5	62	51	10
10	20	35.5	62	66	10
12	20	35.5	62	79	10

3011M-100 (mm)	D (mm)	H (mm)	L (mm)	(g)	(pcs.)
3	18	73.5	100	61	10
4	18	73.5	100	62	10
5	18	73.5	100	64	10
6	18	73.5	100	65	10
7	18	73.5	100	67	10
8	18	73.5	100	68	10
10	20	73.5	100	91	10

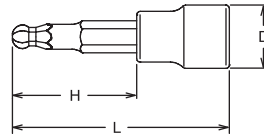
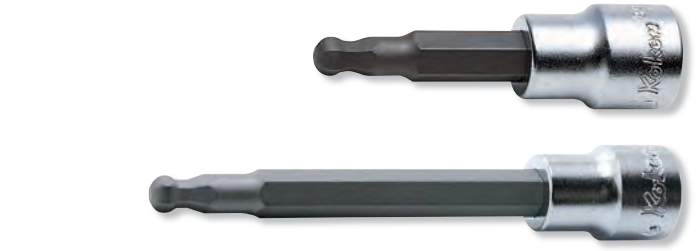

3011M-120 (mm)	D (mm)	H (mm)	L (mm)	(g)	(pcs.)
3	18	93.5	120	77	10
4	18	93.5	120	78	10
5	18	93.5	120	80	10
6	18	93.5	120	81	10
7	18	93.5	120	83	10
8	18	93.5	120	84	10

3011M-160 (mm)	D (mm)	H (mm)	L (mm)	(g)	(pcs.)
3	18	133.5	160	87	10
4	18	133.5	160	88	10
5	18	133.5	160	89	10
6	18	133.5	160	91	10
7	18	133.5	160	93	10
8	18	133.5	160	95	10



 Ballpoint bit sockets have less strength due to the special design. Make sure to use them correctly.  
Kugelkopf-Biteinsätze haben aufgrund der speziellen Form eine geringere Festigkeit. Achten Sie darauf, diese richtig zu verwenden.  
Les douilles à tête sphérique sont moins résistantes en raison de leur conception spéciale. Veuillez les utiliser correctement.

## 3015M-62 / -100

 Inhex Bit Socket, **Grip Ring**  
Steckschlüssel mit Grip Ring für Innensechskant-Schrauben   
Douilles tournevis avec anneaux pour vis 6-pans creux

3015M-62 (mm)	D (mm)	H <sub>1</sub> (mm)	H <sub>2</sub> (mm)	L (mm)	(g)	(pcs.)
3	18	8.5	35.5	62	43	10
4	18	8.5	35.5	62	45	10
5	18	8.5	35.5	62	50	10
6	18	8.5	35.5	62	50	10
7	18	8.5	35.5	62	50	10
8	18	-	35.5	62	62	10
10	20	-	35.5	62	75	10
12	20	-	35.5	62	95	10

3015M-100 (mm)	D (mm)	H <sub>1</sub> (mm)	H <sub>2</sub> (mm)	L (mm)	(g)	(pcs.)
3	18	12	73.5	100	60	10
4	18	15.5	73.5	100	60	10
5	18	15.5	73.5	100	65	10
6	18	15.5	73.5	100	65	10
7	18	15.5	73.5	100	70	10
8	18	-	73.5	100	70	10
10	20	-	73.5	100	105	10
12	20	-	73.5	100	135	10

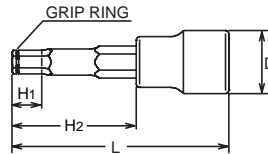

Grip Ring holds hex screws

 Grip Ring bit sockets have less strength due to the special design. Make sure to use them correctly.  
Grip Ring Bit-Einsätze haben aufgrund ihrer speziellen Konstruktion eine geringere Festigkeit. Achten Sie darauf, diese richtig zu verwenden.  
Les douilles avec bague de préhension sont moins résistantes en raison de leur conception spéciale. Veuillez les utiliser correctement.

RS3015M/8-L62	8 Pieces Set/Rail 200mm	(g)
3, 4, 5, 6, 7, 8, 10, 12		500

RS3015M/8-L100	8 Pieces Set/Rail 200mm	(g)
3, 4, 5, 6, 7, 8, 10, 12		650

**RS3015M/8-L62**   Socket Set on Rail  
**RS3015M/8-L100**   Steckschlüsselsatz auf Schiene  
Jeu de douilles sur rail



## 3020-38 / -50 / -100 / -120



XZN Bit Sockets  
Steckschlüssel für XZN Schrauben  
Douilles tournevis pour empreinte XZN

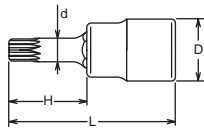

3020-38 (XZN)	D (mm)	d (mm)	H (mm)	L (mm)	(g)	(pcs.)
M 5	18	7.8	11.5	38	32	10
M 6	18	7.8	11.5	38	33	10
M 8	18	7.8	11.5	38	36	10
M10	20	11.9	11.5	38	51	10
M12	20	11.9	11.5	38	52	10
M14	22	13.9	11.5	38	74	10

3020-50 (XZN)	D (mm)	d (mm)	H (mm)	L (mm)	(g)	(pcs.)
M 4	18	7.8	23.5	50	35	10
M 5	18	7.8	23.5	50	37	10
M 6	18	7.8	23.5	50	39	10
M 8	18	7.8	23.5	50	40	10
M10	20	11.9	23.5	50	65	10
M12	20	11.9	23.5	50	69	10
M14	22	13.9	23.5	50	75	10

3020-100 (XZN)	D (mm)	d (mm)	H (mm)	L (mm)	(g)	(pcs.)
M 4	18	7.8	73.5	100	57	10
M 5	18	7.8	73.5	100	59	10
M 6	18	7.8	73.5	100	61	10
M 8	18	7.8	73.5	100	62	10
M10	20	11.9	73.5	100	99	10
M12	20	11.9	73.5	100	103	10
M14	22	13.9	73.5	100	145	5

3020-120 (XZN)	D (mm)	d (mm)	H (mm)	L (mm)	(g)	(pcs.)
M 4	18	7.8	93.5	120	77	10
M 5	18	7.8	93.5	120	79	10
M 6	18	7.8	93.5	120	81	10
M 8	18	7.8	93.5	120	82	10
M10	20	11.9	93.5	120	119	10
M12	20	11.9	93.5	120	123	10
M14	22	13.9	93.5	120	165	5

## RS3020/6-L38



Socket Set on Rail  
Steckschlüsselsatz auf Schiene  
Jeu de douilles sur rail



RS3020/6-L38	6 Pieces Set/Rail 150mm	(g)
M5, M6, M8, M10, M12, M14		308

## RS3020/7-L50



Socket Set on Rail  
Steckschlüsselsatz auf Schiene  
Jeu de douilles sur rail



RS3020/7-L50	7 Pieces Set/Rail 200mm	(g)
M4, M5, M6, M8, M10, M12, M14		400

### XZN

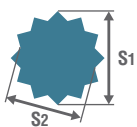

XZN		M4	M5	M6	M8	M10	M12	M14	M16	M18
S <sub>1</sub>	(ref. mm)	3.6	4.8	6.1	7.3	9.7	11.5	13.3	15.7	16.9
S <sub>2</sub>	(ref. mm)	3.1	4.1	5.1	6.1	8.1	9.7	11.2	13.2	14.2

# 3/8"

Hand Sockets  
Hand Steckschlüssel  
Douilles à main

3025-38 (T)	D (mm)	H (mm)	L (mm)	(g)	(pcs.)
T 8	18	11.5	38	32	10
T 9	18	11.5	38	32	10
T10	18	11.5	38	32	10
T15	18	11.5	38	33	10
T20	18	11.5	38	33	10
T25	18	11.5	38	33	10
T27	18	11.5	38	33	10
T30	18	11.5	38	33	10
T40	18	11.5	38	34	10
T45	18	11.5	38	37	10
T50	18	11.5	38	49	10
T55	20	11.5	38	57	10

3025-50 (T)	D (mm)	H (mm)	L (mm)	(g)	(pcs.)
T 8	18	23.5	50	36	10
T 9	18	23.5	50	36	10
T10	18	23.5	50	36	10
T15	18	23.5	50	36	10
T20	18	23.5	50	36	10
T25	18	23.5	50	37	10
T27	18	23.5	50	37	10
T30	18	23.5	50	38	10
T40	18	23.5	50	39	10
T45	18	23.5	50	41	10
T50	18	23.5	50	55	10
T55	20	23.5	50	67	10

RS3025/8-L38	8 Pieces Set/Rail 200mm	(g)
T10, T15, T20, T25, T27, T30, T40, T45		300

RS3025/8-L50	8 Pieces Set/Rail 200mm	(g)
T10, T15, T20, T25, T27, T30, T40, T45		320

RS3025/8-L140KE	8 Pieces Set/Rail 200mm	(g)
T20, T25, T27, T30, T40, T45, T50, T55		700

## 3025-38 / -50 / -140 (T)

TORX® Bit Sockets  
TORX® Bit-Steckschlüssel  
Douilles tournevis, TORX®

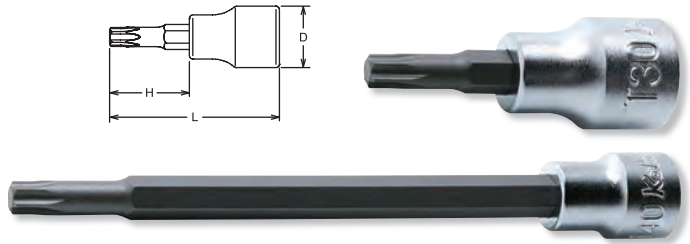

3025-140 (T)	D (mm)	H (mm)	L (mm)	(g)	(pcs.)
T 9	18	113.5	140	75	10
T10	18	113.5	140	75	10
T15	18	113.5	140	75	10
T20	18	113.5	140	75	10
T25	18	113.5	140	76	10
T27	18	113.5	140	76	10
T30	18	113.5	140	77	10
T40	18	113.5	140	78	10
T45	18	113.5	140	80	10
T50	20	113.5	140	94	10
T55	20	113.5	140	106	10

## RS3025/8-L38

## RS3025/8-L50

## RS3025/8-L140KE

Socket Set on Rail  
Steckschlüsselsatz auf Schiene  
Jeu de douilles sur rail



### TORX® (T)

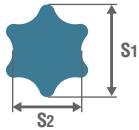

T	T8	T9	T10	T15	T20	T25	T27	T30	T40	T45	T50	T55	T60	T70	T80	T90	T100
S <sub>1</sub> (ref. mm)	2.3	2.5	2.7	3.3	3.9	4.5	5.0	5.6	6.7	7.9	8.9	11.3	13.3	15.6	17.6	20.0	22.2
S <sub>2</sub> (ref. mm)	1.7	1.8	2.0	2.3	2.8	3.2	3.6	4.0	4.8	5.6	6.2	8.0	9.5	11.1	12.7	14.2	15.8

3025-50	D (mm)	H (mm)	L (mm)	(g)	(pcs.)
T35	18	23.5	50	39	10

3025-100R (T)	D (mm)	d (mm)	H (mm)	L (mm)	(g)	(pcs.)
T20	18	4	73.5	100	38	10
T25	18	4.6	73.5	100	40	10
T27	18	5.2	73.5	100	42	10
T30	18	5.7	73.5	100	45	10
T40	18	6.8	73.5	100	52	10
T45	18	8	73.5	100	73	10
T50	20	9	73.5	100	80	10
T55	20	11.4	73.5	100	106	10

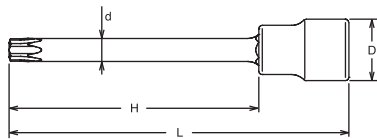

RS3025/8-L100R	8 Pieces Set/Rail 200mm	(g)
T20, T25, T27, T30, T40, T45, T50, T55		490

## 3025-50-T35

Bit Socket  
Bit-Steckschlüssel  
Douilles tournevis



## 3025-100R (T)

TORX® Bit Sockets, round-shaft  
TORX® Bit-Steckschlüssel mit Rundschaft  
Douilles tournevis TORX® avec manche ronde



## RS3025/8-L100R

Socket Set on Rail  
Steckschlüsselsatz auf Schiene  
Jeu de douilles sur rail



Z-SERIES  
HAND  
TITANIUM  
ACCESSORIES  
SCREWDRIVERS  
IMPACT  
SLEEVE-DRIVE  
PROTECTOR  
INDUSTRIAL  
AUTOMOTIVE  
MOTORCYCLE  
CONSTRUCTION  
SPARE PART

## 3025-50 / -160 (TH)

Tamper Resistant TORX® Bit Sockets  
Tamper Resistant TORX® Bit-Steckschlüssel  
Douilles tournevis, Tamper-Resistant TORX®



Tamper Resistant TORX® Bit Sockets have less strength due to special design. Make sure to use it correctly.

Bitte beachten Sie die geringere Belastbarkeit der Tamper Resistant Torx Steckschlüssel.

Veuillez respecter la capacité de charge inférieure des douilles Tamper Resistant Torx

3025-50 (TH)	D (mm)	H (mm)	L (mm)	(g)	(pcs.)
T10H	18	23.5	50	37	10
T15H	18	23.5	50	38	10
T20H	18	23.5	50	38	10
T25H	18	23.5	50	38	10
T27H	18	23.5	50	38	10
T30H	18	23.5	50	39	10
T40H	18	23.5	50	40	10
T45H	18	23.5	50	41	10
T50H	18	23.5	50	61	10
T55H	20	23.5	50	61	10

3025-160 (TH)	D (mm)	H (mm)	L (mm)	(g)	(pcs.)
T25H	18	133.5	160	83	10
T27H	18	133.5	160	83	10
T30H	18	133.5	160	84	10
T40H	18	133.5	160	85	10
T45H	18	133.5	160	86	10
T50H	20	133.5	160	128	10
T55H	20	133.5	160	128	10

## RS3025/9-HOLE

Socket Set on Rail  
Steckschlüsselsatz auf Schiene  
Jeu de douilles sur rail



RS3025/9-HOLE	9 Pieces Set/Rail 200mm	(g)
T10H, T15H, T20H, T25H, T27H, T30H, T40H, T45H, T50H		405

## 3247

Bit Socket Set  
Schraubendreher-Steckschlüssel Satz  
Jeu de douilles de vissage



3247	4 Pieces Set/ =385g
PLASTIC BAG	
Sockets	
3025.160 Tamper-Resistant TORX® Bit Sockets	T27H, T30H, T40H, T50H

## 3025-100R (TH)

Tamper-Resistant TORX® Bit Sockets, round-shaft  
Tamper-Resistant TORX® Bit-Steckschlüssel mit Rundschaft  
Douilles tournevis, Tamper-Resistant TORX® avec manche ronde

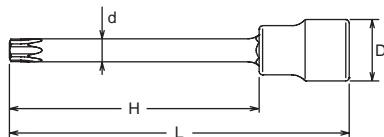

3025-100R (TH)	D (mm)	d (mm)	H (mm)	L (mm)	(g)	(pcs.)
T20H	18	4	73.5	100	38	10
T25H	18	4.6	73.5	100	40	10
T27H	18	5.2	73.5	100	42	10
T30H	18	5.7	73.5	100	45	10
T40H	18	6.8	73.5	100	52	10
T45H	18	8	73.5	100	73	10
T50H	20	9	73.5	100	80	10
T55H	20	11.4	73.5	100	106	10

## RS3025/8-L100RH

Socket Set on Rail  
Steckschlüsselsatz auf Schiene  
Jeu de douilles sur rail



RS3025/8-L100RH	8 Pieces Set/Rail 200mm	(g)
T20H, T25H, T27H, T30H, T40H, T45H, T50H, T55H		490

# 3/8"

Hand Sockets  
Hand Steckschlüssel  
Douilles à main

3025-50 (IP)	D (mm)	H (mm)	L (mm)	(g)	(pcs.)
10IP	18	23.5	50	38	10
15IP	18	23.5	50	38	10
20IP	18	23.5	50	38	10
25IP	18	23.5	50	38	10
27IP	18	23.5	50	40	10
30IP	18	23.5	50	40	10
40IP	18	23.5	50	41	10
45IP	18	23.5	50	41	10
50IP	20	23.5	50	61	10
55IP	20	23.5	50	61	10

RS3025/8-IP	8 Pieces Set/Rail 200mm	(g)
20IP, 25IP, 27IP, 30IP, 40IP, 45IP, 50IP, 55IP		370

RSX025/11-IP	11 Pieces Set/Rail 200mm	(g)
2025.28(IP)	10IP, 15IP, 20IP, 25IP, 27IP	480
3025.50(IP)	30IP, 40IP, 45IP, 50IP	
4025.60(IP)	55IP, 60IP	

1/4" + 3/8" + 1/2"

TORXPLUS® (IP)

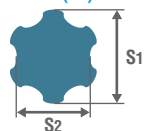

IP	8IP	9IP	10IP	15IP	20IP	25IP	27IP	30IP	40IP	45IP	50IP	55IP	60IP	70IP
S <sub>1</sub>	(ref. mm) 2.3	2.5	2.7	3.3	3.9	4.5	5.0	5.6	6.7	7.9	8.9	11.3	13.3	15.6
S <sub>2</sub>	(ref. mm) 1.8	1.9	2.1	2.5	3.0	3.4	3.9	4.3	5.2	6.2	6.9	9.0	10.4	12.3

## 3025-50 (IP)

TORXPLUS® Bit Sockets  
TORXPLUS® Bit-Steckschlüssel  
Douilles tournevis, TORXPLUS®

**TORXplus**

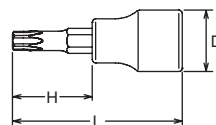

## RS3025/8-IP

Socket Set on Rail  
Steckschlüsselsatz auf Schiene  
Jeu de douilles sur rail



## RSX025/11-IP

Socket Set on Rail  
Steckschlüsselsatz auf Schiene  
Jeu de douilles sur rail



# TORXplus®

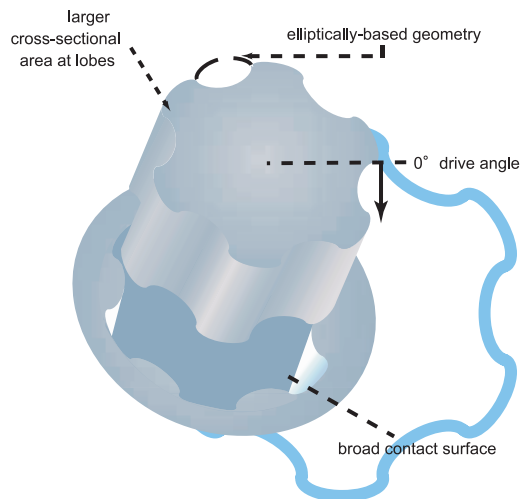
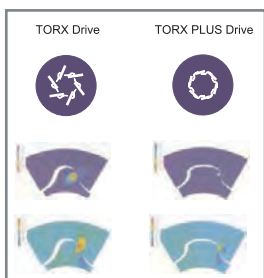
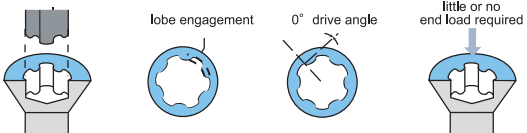

Z-SERIES  
HAND  
TITANIUM  
SCREWDRIVERS ACCESSORIES  
IMPACT  
SLEEVE-DRIVE  
PROTECTOR  
INDUSTRIAL  
AUTOMOTIVE  
CONSTRUCTION MOTORCYCLE  
SPARE PART

## 3025-50 (IPR)

Tamper-Resistant TORXPLUS® Bit Sockets  
Tamper-Resistant TORXPLUS® Bit-Steckschlüssel  
Douilles tournevis TORXPLUS® avec trou

**TORXplus®**



3025-50 (IPR)	D (mm)	H (mm)	L (mm)	(g)	(pcs.)
10IPR	18	23.5	50	38	10
15IPR	18	23.5	50	38	10
20IPR	18	23.5	50	38	10
25IPR	18	23.5	50	38	10
27IPR	18	23.5	50	40	10
30IPR	18	23.5	50	40	10
40IPR	18	23.5	50	41	10
45IPR	18	23.5	50	41	10
50IPR	20	23.5	50	61	10
55IPR	20	23.5	50	61	10

## RS3025/9-IPR

Socket Set on Rail  
Steckschlüsselsatz auf Schiene  
Jeu de douilles sur rail



RS3025/9-IPR	9 Pieces Set/Rail 200mm	(g)
10IPR, 15IPR, 20IPR, 25IPR, 27IPR, 30IPR, 40IPR, 45IPR, 50IPR		395

## RSX025/11-IPR

Socket Set on Rail  
Steckschlüsselsatz auf Schiene  
Jeu de douilles sur rail



RSX025/11-IPR	11 Pieces Set/Rail 200mm	(g)
2025.28(IPR)	8IPR, 10IPR, 15IPR, 20IPR, 25IPR, 27IPR, 30IPR	320
3025.50(IPR)	40IPR, 45IPR, 50IPR, 55IPR	

1/4" + 3/8"

**TORXPLUS® (IPR)**

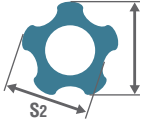

IPR	8IPR	9IPR	10IPR	15IPR	20IPR	25IPR	27IPR	30IPR	40IPR	45IPR	50IPR	55IPR	
S <sub>1</sub>	(ref. mm)	2.2	2.4	2.6	3.1	3.6	4.1	4.7	5.2	6.3	7.4	8.4	10.6
S <sub>2</sub>	(ref. mm)	2.0	2.2	2.4	2.8	3.3	3.8	4.3	4.8	5.7	6.7	7.6	9.7

## 3027-50 / -100

Bit Sockets for Ribe Screws  
Steckschlüsselklingen für Ribe Schrauben  
Douilles tournevis pour écrous profil Ribe

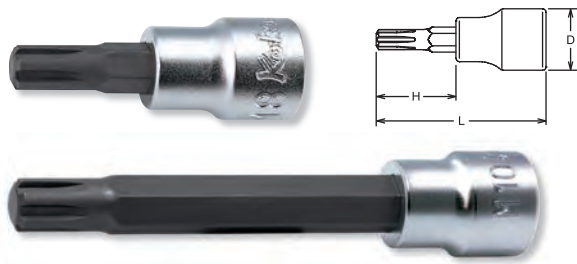

3027-50	D (mm)	H (mm)	L (mm)	(g)	(pcs.)
M 5	18	23.5	50	38	10
M 6	18	23.5	50	38	10
M 7	18	23.5	50	38	10
M 8	18	23.5	50	39	10
M 9	20	23.5	50	40	10
M10	20	23.5	50	40	10
M12	20	23.5	50	41	10

3027-100	D (mm)	H (mm)	L (mm)	(g)	(pcs.)
M 5	18	73.5	100	40	10
M 6	18	73.5	100	42	10
M 8	18	73.5	100	45	10
M10	20	73.5	100	52	10
M12	20	73.5	100	73	10

## RS3027/5-L50

Socket Set on Rail  
Steckschlüsselsatz auf Schiene  
Jeu de douilles sur rail



RS3027/5-L50	5 Pieces Set/Rail 150mm	(g)
M5, M6, M8, M10, M12		240

**Ribe CV**

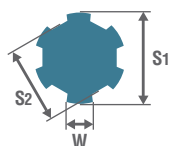

CV	M5	M6	M7	M8	M9	M10	M12	M13	M14	M16
W	(ref. mm)	1.2	1.3	1.4	1.8	2.0	2.3	2.6	3.1	3.6
S <sub>1</sub>	(ref. mm)	5.0	6.0	7.0	8.0	9.0	10.0	12.0	13.0	16.0
S <sub>2</sub>	(ref. mm)	3.8	4.5	5.0	6.0	7.1	7.4	9.0	11.0	11.9

3110M (mm)	D (mm)	H (mm)	L (mm)	(g)	(pcs.)
6	18	10	28	30	10
8	18	10	28	30	10
10	18	10	28	33	10
12	18	10	28	37	10

3110A (inch)	D (mm)	H (mm)	L (mm)	(g)	(pcs.)
5/16	18	10	28	30	10
3/8	18	10	28	33	10
1/2	18	10	28	37	10

## 3110M / 3110A

4-point Male Sockets  
Öldienst-Steckschlüssel  
Douilles mâles 4-pans

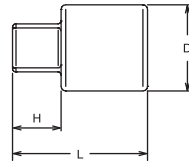

3119 (mm)	T <sub>1</sub> x T <sub>2</sub> (mm)	D <sub>1</sub> (mm)	D <sub>2</sub> (mm)	d (mm)	L (mm)	(g)	(pcs.)
3 x 5	3 x 5	17	17.3	11	30	30	10
5.5 x 6	5.5 x 6	21	19.5	14	33	45	10



For Wing Bolt  
Für Flügelschrauben  
Pour écrous à oreilles

For Drain Plug in Radiator  
Für Kühler-Ablasschrauben  
Pour le vidange du radiateur

## 3119

Wing Bolt Socket  
Steckschlüssel für Flügelschrauben  
Douilles pour écrous à oreilles

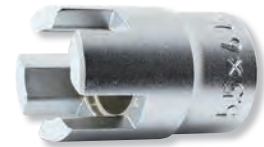
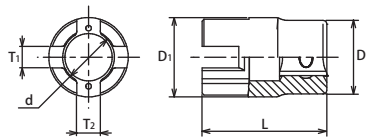

3137	D <sub>1</sub> (mm)	D <sub>2</sub> (mm)	L (mm)	(g)	(pcs.)
3137	13	16.5	30	30	10

For DIN3126 C6.3 Bits  
Für DIN3126 C6.3 Bits  
Pour DIN3126 C6.3 Embouts

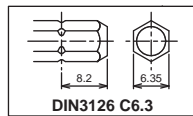

## 3137

Bit Holder  
Klingenhalter  
Porte-embouts

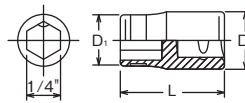

3138	D <sub>1</sub> (mm)	D <sub>2</sub> (mm)	L (mm)	(g)	(pcs.)
3138	16	18	38	55	10

For DIN3126 C8 Bits  
Für DIN3126 C8 Bits  
Pour DIN3126 C8 Embouts

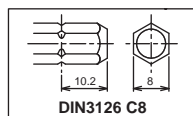

## 3138

Bit Holder  
Klingenhalter  
Porte-embouts

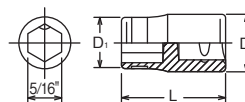

Z-SERIES  
HAND  
TITANIUM  
SCREWDRIVERS ACCESSORIES  
IMPACT  
SLEEVE-DRIVE  
PROTECTOR  
INDUSTRIAL  
AUTOMOTIVE  
MOTORCYCLE  
CONSTRUCTION  
SPARE PART

## 2749PS-3/8

Reversible Ratchet (Short)  
Knarre kurz, verstellbar  
Cliquet court, réversible

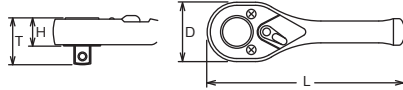

\* Renewal Kits → 2749RK-3/8 → P318

	D (mm)	T (mm)	H (mm)	L (mm)	(g)	(pcs.)
2749PS-3/8	25	21.9	11.2	75	70	10

## 2749P-3/8

Reversible Ratchet  
Knarre, verstellbar  
Cliquet, réversible

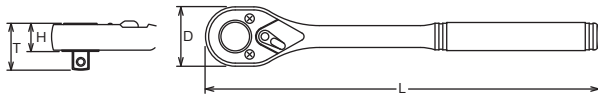

\* Renewal Kits → 2749RK-3/8 → P318

	D (mm)	T (mm)	H (mm)	L (mm)	(g)	(pcs.)
2749P-3/8	25	21.9	11.2	125	101	1

⚠ 2749-3/8 series have less strength compared with normal ratchet due to the technical design. Make sure to use the ratchet correctly.

Die Serie 2749-3/8 hat aufgrund der technischen Konstruktion eine geringere Festigkeit im Vergleich zu einer normalen Ratsche. Stellen Sie sicher, dass Sie die Ratsche richtig verwenden.

La série 2749-3/8 offre une résistance moindre par rapport aux cliquets 3/8" normaux en raison de leur conception technique. Veillez à l'utiliser correctement.

## 3749S

Reversible Ratchet (Short)  
Knarre kurz, verstellbar  
Cliquet court, réversible



\* Renewal Kits → 3749RK → P318

## 3749SB

Reversible Ratchet with quick release button  
Knarre, verstellbar mit Entriegelungsknopf  
Cliquet, réversible avec bouton de débrayage

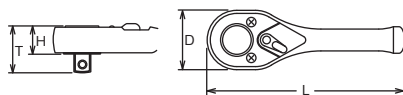

\* Renewal Kits → 3749BRK → P318

	D (mm)	T (mm)	H (mm)	L (mm)	(g)	(pcs.)
3749S	34	24.8	14.1	110	183	5
3749SB	34	24.8	14.1	110	183	5

⚠ Reversible Ratchet with quick release button has less strength compared with normal ratchet due to the technical design. Make sure to use the ratchet correctly.

Die Umschaltknarre mit Entriegelungsknopf hat aufgrund der technischen Konstruktion eine geringere Festigkeit als eine normale Ratsche. Stellen Sie sicher, dass Sie die Ratsche richtig verwenden.

Le cliquet réversible offre une résistance moindre par rapport aux cliquets 3/8" normaux en raison de leur conception technique. Veillez à l'utiliser correctement.

## 3753SM

Multi Purpose Ratchet, reversible  
Knarre mit 2 Vierkantöffnungen, umstellbar  
Cliquet réversible multi fonctionnel

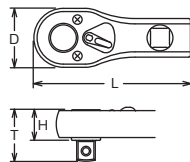

\* Renewal Kits → 3753RK → P318

	D (mm)	T (mm)	H (mm)	L (mm)	(g)	(pcs.)
3753SM	30.5	26.4	15.7	81	175	5

## 3753SMB

Multi Purpose Ratchet, reversible, with quick release button  
Knarre mit 2 Vierkantöffnungen, mit Entriegelungsknopf umstellbar  
Cliquet réversible multi fonctionnel, avec bouton de débrayage

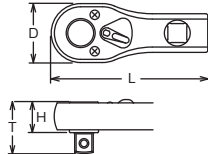

\* Renewal Kits → 3753BRK → P318

	D (mm)	T (mm)	H (mm)	L (mm)	(g)	(pcs.)
3753SMB	30.5	26.4	15.7	81	175	5



## [L/R Marking]



\* Renewal Kits → 3752RK → P319



\* Renewal Kits → 3752RK → P319

A pointer and L/R markings on the ratchet head indicate the turning direction. The reduced diameter of the head allows easier access in tight spots.

Eine L/R Markierung auf dem Knarrenkopf zeigt die gerade eingestellte Drehrichtung an. Der geringe Kopfdurchmesser erleichtert das Arbeiten auch an schwer zugänglichen Stellen.

Un marquage L/R sur la tête de cliquet indique le sens de rotation. Le diamètre de tête réduit facilite le travail dans les endroits difficilement accessibles.

	D (mm)	T (mm)	H (mm)	L (mm)	(g)	(pce.)
3752J	33	34.3	23.9	200	310	1
3752N	33	34.3	23.9	200	310	1



**3752J** Reversible Ratchet  
Knarre, verstellbar  
Cliquet, réversible



**3752N** Reversible Ratchet  
Knarre, verstellbar  
Cliquet, réversible

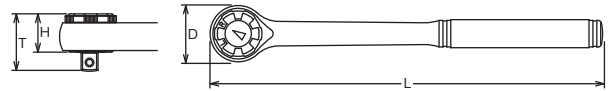

\* Renewal Kits → 3753RK → P318



\* Renewal Kits → 3753RK → P318



\* Renewal Kits → 3753RK → P318



\* Renewal Kits → 3753RK → P318



**3753J** Reversible Ratchet  
Knarre, verstellbar  
Cliquet, réversible



**3753P** Reversible Ratchet  
Knarre, verstellbar  
Cliquet, réversible



**3753N** Reversible Ratchet  
Knarre, verstellbar  
Cliquet, réversible



**D3753J** Reversible Ratchet  
Knarre, verstellbar  
Cliquet, réversible

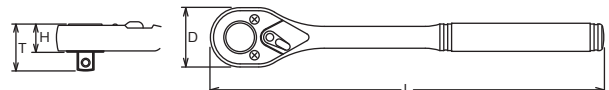

	D (mm)	T (mm)	H (mm)	L (mm)	(g)	(pce.)
3753J	30.5	26.4	15.7	200	260	1
3753P	30.5	26.4	15.7	200	286	1
3753N	30.5	26.4	15.7	200	320	1
D3753J	30.5	26.4	15.7	200	260	1



\* Renewal Kits → 3753RK → P318



**3753P-250** Reversible Ratchet (Long)  
Verstellbare Knarre, lang ⚠  
Cliquet réversible, long

	D (mm)	T (mm)	H (mm)	L (mm)	(g)	(pce.)
3753P-250	30.5	26.4	15.7	250	335	1

⚠ 3753P-250 have longer handle than standard, and can be loaded to excessive torque value. In the interest of your own safety always apply load evenly and progressively to avoid breakage and possible injury.

Sie haben einen längeren Griff als Standardprodukte und können mit einem übermäßigen Drehmoment belastet werden. Im Interesse Ihrer eigenen Sicherheit sollten Sie sie immer gleichmäßig und schrittweise belasten, um Brüche und mögliche Verletzungen zu vermeiden.

Les modèles 3753P-250 ont une poignée plus longue que la norme et peuvent être soumis à un couple excessif. Pour votre sécurité, appliquez toujours la charge de manière uniforme et progressive afin d'éviter toute rupture et blessure.

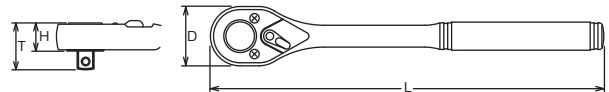

# Hand Sockets Hand Steckschlüssel Douilles à main

## 3/8"

Z-SERIES  
HAND  
TITANIUM  
SCREWDRIVERS ACCESSORIES  
IMPACT  
SLEEVE-DRIVE  
PROTECTOR  
INDUSTRIAL  
AUTOMOTIVE  
CONSTRUCTION MOTORCYCLE  
SPARE PART

**3753JB** Reversible Ratchet with quick release button  
Knarre, verstellbar mit Entriegelungsknopf  
Cliquet, réversible avec bouton de débrayage



\* Renewal Kits → **3753BRK** → P318

**3753PB** Reversible Ratchet with quick release button  
Knarre, verstellbar mit Entriegelungsknopf  
Cliquet, réversible avec bouton de débrayage



\* Renewal Kits → **3753BRK** → P318

**3753NB** Reversible Ratchet with quick release button  
Knarre, verstellbar mit Entriegelungsknopf  
Cliquet, réversible avec bouton de débrayage



\* Renewal Kits → **3753BRK** → P318

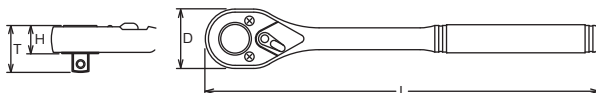

	D (mm)	T (mm)	H (mm)	L (mm)	(g)	(pce.)
<b>3753JB</b>	30.5	26.4	15.7	200	260	1
<b>3753PB</b>	30.5	26.4	15.7	200	286	1
<b>3753NB</b>	30.5	26.4	15.7	200	320	1

⚠ Reversible Ratchet with quick release button has less strength compared with normal ratchet due to the technical design. Make sure to use the ratchet correctly.

Die Umschaltknarre mit Entriegelungsknopf hat aufgrund der technischen Konstruktion eine geringere Festigkeit als eine normale Ratsche. Stellen Sie sicher, dass Sie die Ratsche richtig verwenden.

Le cliquet réversible avec bouton de débrayage a une résistance moindre que le cliquet normal en raison de sa conception technique. Veuillez utiliser le cliquet correctement.

**2774JS-3/8** Flexible Ratchet, reversible  
Gelenk-Knarre, verstellbar  
Cliquet articulé, réversible



\* Renewal Kits → **2749RK-3/8** → P318

**2774PS-3/8** Flexible Ratchet, reversible  
Gelenk-Knarre, verstellbar  
Cliquet articulé, réversible



\* Renewal Kits → **2749RK-3/8** → P318

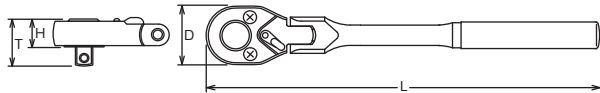

	D (mm)	T (mm)	H (mm)	L (mm)	(g)	(pce.)
<b>2774JS-3/8</b>	25	21.9	11.2	120	113	1
<b>2774PS-3/8</b>	25	21.9	11.2	120	133	1

⚠ 2774-3/8 series have less strength compared with normal  ratchet due to the technical design. Make sure to use the ratchet correctly.

Die Serie 2774-3/8 hat aufgrund der technischen Konstruktion eine geringere Festigkeit im Vergleich zu einer normalen Ratsche. Stellen Sie sicher, dass Sie die Ratsche richtig verwenden.

La série 2774-3/8 offre une résistance moindre par rapport aux cliquets 3/8" normaux en raison de leur conception technique. Veuillez à l'utiliser correctement.

**3774PS** Flexible Ratchet, reversible  
Gelenk-Knarre, verstellbar  
Cliquet articulé, réversible



\* Renewal Kits → **3753RK** → P318

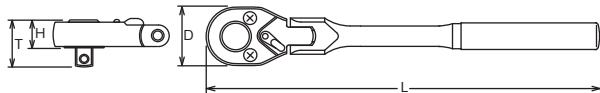

	D (mm)	T (mm)	H (mm)	L (mm)	(g)	(pce.)
<b>3774PS</b>	30.5	26.4	15.7	175	250	1

# 3/8" Hand Sockets Hand Steckschlüssel Douilles à main

Z-SERIES  
HAND  
TITANIUM  
ACCESSORIES  
SCREWDRIVERS  
IMPACT  
SLEEVE-DRIVE  
PROTECTOR  
INDUSTRIAL  
AUTOMOTIVE  
MOTORCYCLE  
CONSTRUCTION  
SPARE PART



**3774J** Flexible Ratchet, reversible  
Gelenk-Knarre, verstellbar  
Cliquet articulé, réversible

\* Renewal Kits → 3753RK → P318

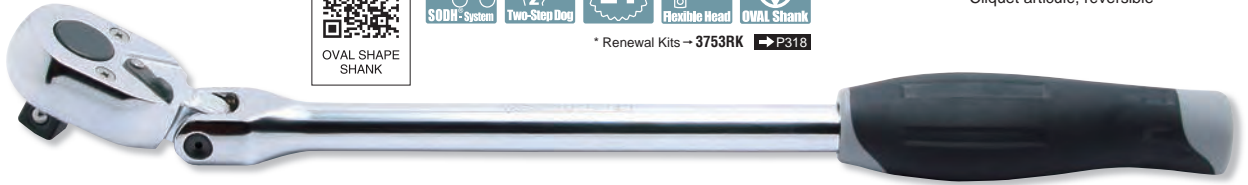

**3774P** Flexible Ratchet, reversible  
Gelenk-Knarre, verstellbar  
Cliquet articulé, réversible

\* Renewal Kits → 3753RK → P318



**3774N** Flexible Ratchet, reversible  
Gelenk-Knarre, verstellbar  
Cliquet articulé, réversible

\* Renewal Kits → 3753RK → P318



	D (mm)	T (mm)	H (mm)	L (mm)	(g)	(pce.)
3774J	30.5	26.4	15.7	285	367	1
3774P	30.5	26.4	15.7	265	378	1
3774N	30.5	26.4	15.7	265	378	1

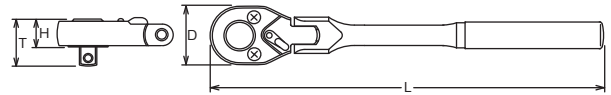

\* Renewal Kits → 3753BRK → P318

**3774JB**  
**3774PB**  
**3774NB**

Flexible Ratchet, reversible with quick release button  
Gelenk-Knarre, verstellbar mit Entriegelungsknopf  
Cliquet articulé, réversible avec bouton de débrayage



	D (mm)	T (mm)	H (mm)	L (mm)	(g)	(pce.)
3774JB	30.5	26.4	15.7	285	367	1
3774PB	30.5	26.4	15.7	265	373	1
3774NB	30.5	26.4	15.7	265	378	1

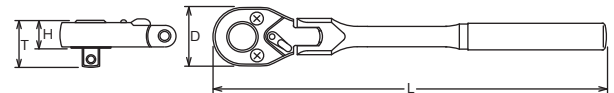

**⚠** Reversible Ratchet with quick release button has less strength compared with normal ratchet due to the technical design. Make sure to use the ratchet correctly.

Die Umschaltknarre mit Entriegelungsknopf hat aufgrund der technischen Konstruktion eine geringere Festigkeit als eine normale Ratsche. Stellen Sie sicher, dass Sie die Ratsche richtig verwenden.

Le cliquet réversible avec bouton de libération rapide a une résistance moindre que le cliquet normal en raison de sa conception technique. Veuillez à utiliser le cliquet correctement.

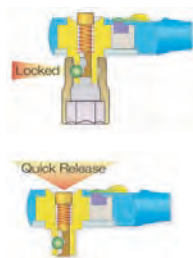
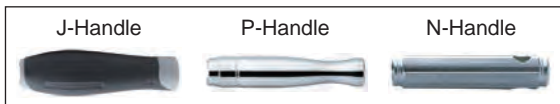

**Reversible Ratchet with Quick Release Button :**  
Sockets and accessories are safely locked. By pushing the button the sockets or extension bars are released from the ratchet.

**Umstellbare Knarre mit Entriegelungsknopf :**  
Steckschlüssel und Zubehörteile werden sicher und fest gehalten. Bei Drücken des Knopfes lösen sich die Teile.

**Cliquet réversible avec bouton de débrayage :**  
Les douilles et accessoires sont bien fixés. En poussant le bouton ils se libèrent facilement.



\* Renewal Kits → 3753RK → P318

**3774JL**  
**3774PL**  
**3774NL**

Flex-Head Ratchet with Head Lock Button  
Gelenk-Knarre, mit feststellbarem Gelenk  
Cliquet à tête articulée avec articulation verrouillable

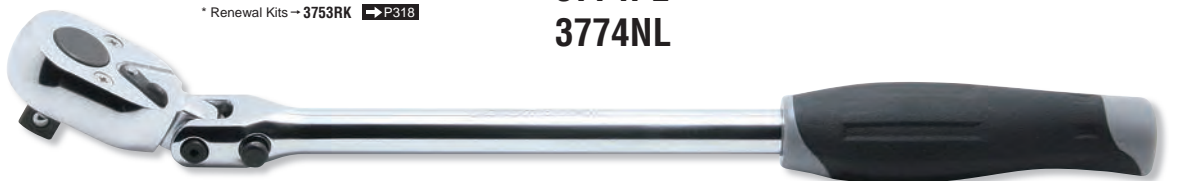

	D (mm)	T (mm)	H (mm)	L (mm)	(g)	(pce.)
3774JL	30.5	26.4	15.7	285	367	1
3774PL	30.5	26.4	15.7	265	378	1
3774NL	30.5	26.4	15.7	265	378	1

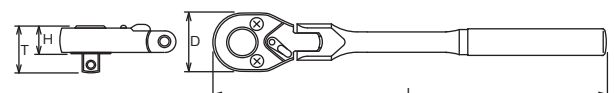

Z-SERIES  
HAND  
TITANIUM  
SCREWDRIVERS  
ACCESSORIES  
IMPACT  
SLEEVE-DRIVE  
PROTECTOR  
INDUSTRIAL  
AUTOMOTIVE  
MOTORCYCLE  
CONSTRUCTION  
SPARE PART

### 3774JBL Flex-Head Ratchet with Head Lock Button and Quick Release Button

Gelenk-Knarre, mit feststellbarem Gelenk und Entriegelungsknopf  
Cliquet à tête articulée avec articulation verrouillable et bouton de débrayage



\* Renewal Kits → 3753BRK → P318

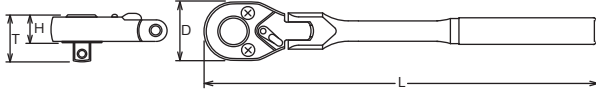

	D (mm)	T (mm)	H (mm)	L (mm)	(g)	(pce.)
3774JBL	30.5	26.4	15.7	285	367	1

⚠ Reversible Ratchet with quick release button has less strength compared with normal ratchet due to the technical design. Make sure to use the ratchet correctly.

Die Umschaltknarre mit Entriegelungsknopf hat aufgrund der technischen Konstruktion eine geringere Festigkeit als eine normale Ratsche. Stellen Sie sicher, dass Sie die Ratsche richtig verwenden.

Le cliquet réversible avec bouton de débrayage rapide a une résistance moindre que le cliquet normal en raison de sa conception technique. Veuillez utiliser le cliquet correctement.

### 3774P-SR Speeder Ratchet

Kurbel-Knarre  
Vielebrequin à cliquet

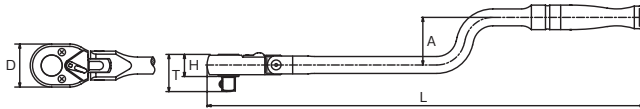

\* Renewal Kits → 3753RK → P318



	D (mm)	T (mm)	H (mm)	A (mm)	L (mm)	(g)	(pce.)
3774P-SR	30.5	26.4	15.7	34	310	435	1

### 3776J Swivel Head Ratchet

Schwenkopf-Knarre  
Cliquet à tête pivotante



\* Renewal Kits → 3752RK → P319



### 3776P Swivel Head Ratchet

Schwenkopf-Knarre  
Cliquet à tête pivotante



\* Renewal Kits → 3752RK → P319



### 3776N Swivel Head Ratchet

Schwenkopf-Knarre  
Cliquet à tête pivotante



\* Renewal Kits → 3752RK → P319

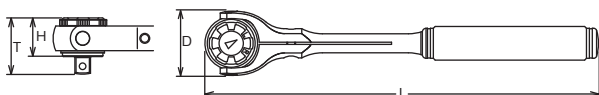

	D (mm)	T (mm)	H (mm)	L (mm)	(g)	(pce.)
3776J	44	34.3	23.9	280	510	1
3776P	44	34.3	23.9	280	560	1
3776N	44	34.3	23.9	280	565	1

45

\* Renewal Kits → 3755RK → P319

	D (mm)	L (mm)	(g)	(pcs.)
3755	30.5	55	146	5

**3755** Ratchet Adaptor  
Aufsteckknarre  
Cliquet adaptable

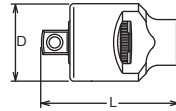

	D (mm)	L (mm)	(g)	(pcs.)
3756	30.5	25.5	47	10

**3756** Quick Spinner  
Rändel-Drehscheibe  
Lanceur

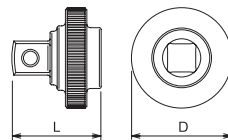

L/R Marking  
45

\* Renewal Kits → 3752RK → P319

	D (mm)	L (mm)	(g)	(pcs.)
3757	50	35	155	5

**3757** Ratchet Wheel  
Umstellbares Knarren-Handrad  
Cliquet réversible à roue

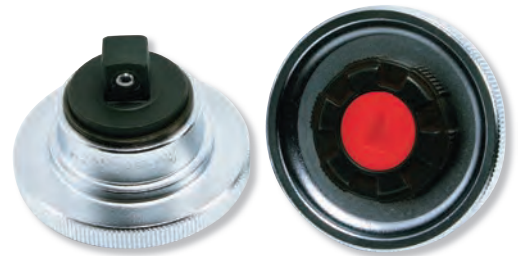
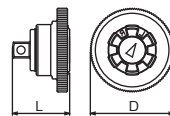

**3762** Flexible Extension Bar  
Biegsame Verlängerung  
Rallonge flexible

	D (mm)	L (mm)	(g)	(pcs.)
3762	19.3	300	178	2

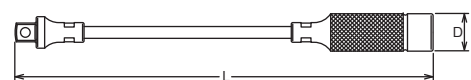

Z-SERIES  
HAND  
TITANIUM  
SCREWDRIVERS ACCESSORIES  
IMPACT  
SLEEVE-DRIVE  
PROTECTOR  
INDUSTRIAL  
AUTOMOTIVE  
MOTORCYCLE  
CONSTRUCTION  
SPARE PART

### 3760

Extension Bars  
Verlängerungen  
Rallonges

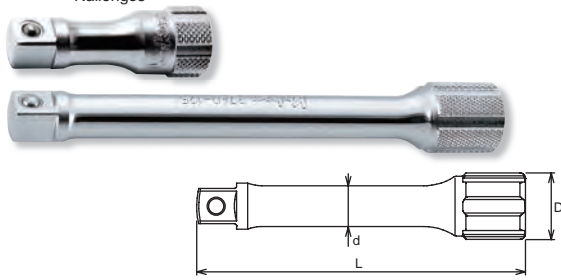

### PK3760/6

Extension Set in Plastic Box  
Verlängerungen in Kunststoffkassette  
Jeu de rallonges en boîte plastique



### 3763

Wobble-Fix Extension Bars  
Winkel-Verlängerungen  
Rallonges angulaires

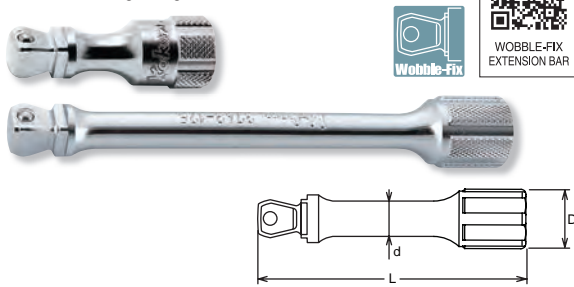

### PK3763/6

Wobble-Fix Extension Bars in Plastic Box  
Winkel-Verlängerungen in Kunststoffkassette  
Jeu de rallonges angulaires en boîte plastique



### 3763L

Locking Wobble-Fix Extension Bars  
Verriegelbare Winkel-Verlängerungen  
Rallonges angulaires verrouillables

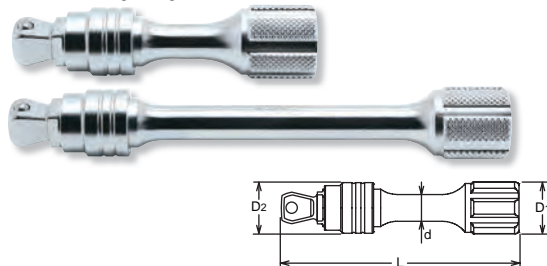

### PK3763L/3

Locking Wobble-Fix Extension Bars in Plastic Box  
Verriegelbare Winkel-Verlängerungen in Kunststoff-Kassette  
Rallonges angulaires verrouillables en boîte plastique



	D (mm)	d (mm)	L (mm)	(g)	(pcs.)
3760-32	18	12.5	32	27	10
3760-50	18	11	50	47	10
3760-75	18	11	75	68	10
3760-125	18	11	125	106	10
3760-150	18	11	150	125	10
3760-250	18	11	250	196	5
3760-300	18	12.5	300	291	2
3760-400	18	12.5	400	365	1
3760-500	18	12.5	500	490	1
3760-600	18	12.5	600	538	1
3760-900	18	12.5	900	805	1
3760-1000	18	12.5	1000	968	1

PK3760/6	6 Pieces Set/△=670g
PLASTIC TRAY	
Extension Bars	
3760 Extension Bars 32, 50, 75, 125, 150, 250	

Rotation and general handling of extensions with oily hands is greatly improved with the **Koken** developed 6 point knurling. Also the **Koken** 6 point knurling stops the extensions from rolling around the work area.

Durch die von **Koken** entwickelte 6 fache Rändelung wird die Handhabung deutlich erleichtert. Außerdem wird das Herumrollen der Verlängerungen wirksam verhindert.

La manipulation des rallonges est grandement facilitée par le profil moleté développé par **Koken**. Ce même profil empêche le roulement intempesitif des rallonges sur le plan de travail.

	D (mm)	d (mm)	L (mm)	(g)	(pcs.)
3763-32	18	12.5	32	26	10
3763-50	18	9	50	42	10
3763-75	18	9	75	57	10
3763-125	18	9	125	80	10
3763-150	18	9	150	98	10
3763-250	18	9	250	144	5
3763-300	18	9	300	170	2

PK3763/6	6 Pieces Set/△=560g
PLASTIC TRAY	
Extension Bars	
3763 Wobble-Fix Extension Bars 32, 50, 75, 125, 150, 250	

#### Wobble-Fix Extension Bar

- Two way usage  
a) In a fixed position, as a normal extension bar  
b) In a half-fixed position, as a flexible extension bar providing a 15° angle operation

#### Winkel-Verlängerungen

- Winkelverlängerungen lassen sich in zwei Einstellungen verwenden  
a) voll eingesteckt und starr,  
b) halb eingesteckt, mit einem Arbeitswinkel von 15°.

#### Rallonges angulaires

- Deux utilisations possibles  
a) comme rallonge normale, dans une position fixe  
b) comme une rallonge angulaire avec une possibilité d'inclinaison jusqu'à 15°

**!** The Wobble-Fix Extension Bar has less strength than normal extension bar due to it's specific design with a reduced square drive. Make sure to use it correctly.

Die Wobble-Fix Verlängerungen haben aufgrund ihrer speziellen Konstruktion mit einem reduzierten Vierkanttrieb eine geringere Festigkeit als eine normale Verlängerung. Achten Sie darauf, sie richtig zu verwenden.

La barre d'extension wobble-fix est moins résistante qu'une barre d'extension normale en raison de sa conception spécifique avec un carré d'entraînement réduit. Veuillez l'utiliser correctement.

	D <sub>1</sub> (mm)	D <sub>2</sub> (mm)	d (mm)	L (mm)	(g)	(pcs.)
New 3763L-75	18	17	9	75	71	10
New 3763L-125	18	17	9	125	95	10
New 3763L-250	18	17	9	250	160	5

New PK3763L/3	3 Pieces Set/△=390g
PLASTIC TRAY	
Extension Bars	
3763L Locking Wobble-Fix Extension Bars 75, 125, 250	



\* Renewal Kits → 3768RK → P321



OVAL SHAPE SHANK



RENEWAL KIT FOR HINGE HANDLE

**3768J-250** Hinge Handle  
Gelenkgriff  
Poignée articulée



\* Renewal Kits → 3768RK → P321

**3768P-250** Hinge Handle  
Gelenkgriff  
Poignée articulée



\* Renewal Kits → 3768RK → P321

**3768P-380** Hinge Handle  
Gelenkgriff  
Poignée articulée



	D (mm)	L (mm)	(g)	(pcs.)
3768J-250	20.5	250	248	2
3768P-250	20.5	250	275	5
3768P-380	20.5	380	435	2

3768P-380 has longer handle than standard, and can be loaded to excessive torque value. In the interest of your own safety always apply load evenly and progressively to avoid breakage and possible injury.

Der Gelenkgriff 3768-380 ist länger als die Standardversion. Aus Gründen Ihrer Sicherheit, sollten dies Werkzeug nie ruckartig sondern nach und nach belastet werden, um Bruch und damit verbundene, mögliche Verletzungen zu vermeiden.

Les modèles 3768P-380 ont une poignée plus longue que la norme et peuvent être soumis à un couple excessif. Pour votre sécurité, appliquez toujours la charge de manière uniforme et progressive afin d'éviter toute rupture et blessure.

	H (mm)	L (mm)	(g)	(pcs.)
3769N				
160	50	160	110	2
230	120	230	135	2



WOBBLE-FIX EXTENSION BAR



	H (mm)	L (mm)	(g)	(pcs.)
3769NWF				
160	50	160	110	2
230	120	230	135	2

Plastic or rubber handles are not intended to act as insulation.

Plastik-oder Gummigriffe stellen keinen Isolierschutz dar.

Les poignées en plastique ou en caoutchouc ne garantissent aucune isolation électrique.

	L (mm)	(g)	(pcs.)
3769H	170	210	2

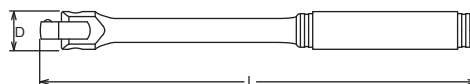

**3769N-160 / -230** Spin Type Handle  
Drehgriff  
Poignée emmanchée

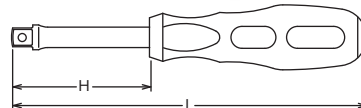

**3769NWF-160 / -230**

Spin Type Handle Wobble-Fix  
Drehgriff, Wobble-Fix  
Poignée emmanchée, angulaire

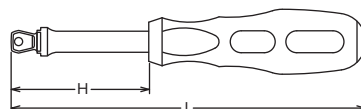

**3769H** Folding Socket Driver  
Klapp-Drehgriff  
Poignée articulée

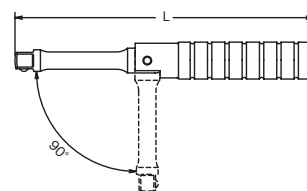

**3770** Universal Joint  
Gelenk-Einsatz  
Cardan universel

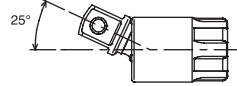
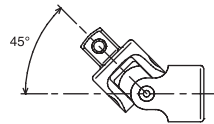
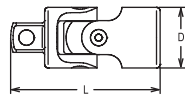

**3771** Universal Joint  
Gelenk-Einsatz  
Joint articulé

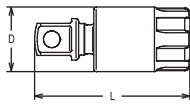

	D (mm)	L (mm)	(g)	(pcs.)
3770	19	50	66	10
3771	18	43	46	10

**3780** Speed Handle  
Winde  
Vilebrequin

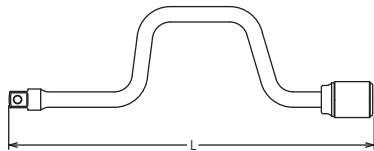

	L (mm)	(g)	(pce.)
3780	400	432	1

**3785** T-Handle  
T-Griff  
Poignée coulissante

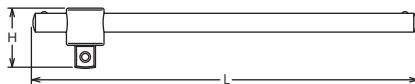
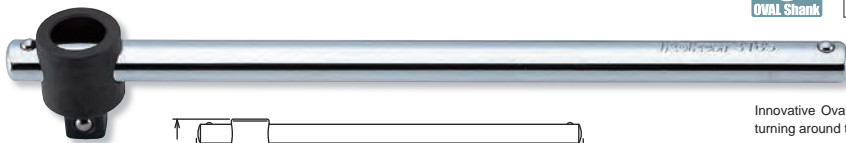

Innovative Oval shaped bar provides higher durability and stops the sliding square part turning around the bar.

La barre ovale innovante offre une plus grande durabilité et empêche la partie carrée coulissante de tourner autour de la barre.



	H (mm)	L (mm)	(g)	(pcs.)
3785	29.5	200	157	5

**3322A** Adaptor  
Verbindungsstück  
Augmentateur

Warranty 86Nm  
Garantie 86Nm  
Garantie 86Nm

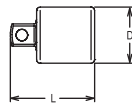

**3344A** Adaptor  
Verbindungsstück  
Augmentateur

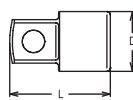

	(sq.)	(sq.)	D (mm)	L (mm)	(g)	(pcs.)
3322A	3/8"	1/4"	16	24	18	10
3344A	3/8"	1/2"	18	30	35	10

**Warning:** Adapting down from bigger square drive to smaller square drive may lead to excessive torque and possibly cause breakage.

Reduzierstücke sind mit Vernunft einzusetzen. Es besteht Bruchgefahr. Überschreiten Sie niemals die Sicherheitsgrenzen.

Les réducteurs doivent être utilisés avec modération. Ne dépassez jamais la limites de sécurité.

**PK2346/6** Adaptor Set in Plastic Box  
Adaptor Satz in Kunststoffkassette  
Jeu d'adpteurs en boîte plastique



- 2233A (11/4") X 3/8"
- 3322A (3/8") X 1/4" Warranty/Garantia 86Nm
- 3344A (3/8") X 1/2"
- 4433A (1/2") X 3/8" Warranty/Garantia 290Nm
- 4466A (1/2") X 3/4"
- 6644A (3/4") X 1/2" Warranty/Garantia 668Nm

**PK2346/6** 6 Pieces Set / 460g  
PLASTIC TRAY

Adaptors	
1/4" □ → 3/8" □ 2233A	3/8" □ → 1/4" □ 3322A
3/8" □ → 1/2" □ 3344A	1/2" □ → 3/8" □ 4433A-35
1/2" □ → 3/4" □ 4466A	3/4" □ → 1/2" □ 6644A

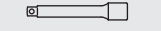
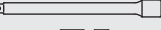
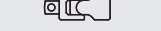
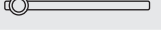
<b>ESH3001</b> 17 Pieces Set/△=2,200g	
METAL CASE:W415xH120xT50mm	
Sockets	Accessories
<b>3410M</b> Surface Drive Sockets 8, 9, 10, 11, 12, 13, 14, 15, 16, 17, 18, 19	 <b>3753J</b>  <b>3760-125</b>  <b>3760-250</b>  <b>3770</b>  <b>3785</b>







**ESH3001** Socket Set  
Steckschlüssel Satz  
Jeu de clés à douille

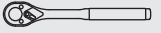

<b>ETH3001</b> 22 Pieces Set/△=1,820g	
METAL CASE:W392xH90xT50mm	
Sockets	Accessory
<b>3425 TORX®</b> Sockets E4, E5, E6, E7, E8 <b>4425 TORX®</b> Sockets E10, E11, E12, E14, E16, E18 <b>3025.50 TORX®</b> Bit Sockets T10, T15, T20, T25, T27 <b>4025.60 TORX®</b> Bit Sockets T30, T40, T45, T50, T55	 <b>4433A-35</b>

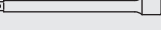
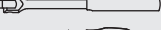

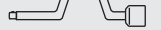
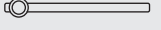
**ETH3001** Socket Set  
Steckschlüssel Satz  
Jeu de clés à douille



<b>3201AMW</b> 42 Pieces Set/△=4,700g	
METAL CASE:W445xH190xT50mm	
Sockets	Accessories
<b>3405M</b> 12-pt. Sockets 9, 10, 11, 12, 13, 14, 15, 16, 17, 18, 19, 20, 21, 22 <b>3405A</b> 12-pt. Sockets 5/16, 3/8, 7/16, 1/2, 9/16, 5/8, 11/16, 3/4, 25/32, 13/16, 7/8 <b>3405W</b> 12-pt. Sockets 1/8, 3/16, 1/4, 5/16, 3/8, 7/16, 1/2	 <b>3753N</b>  <b>3760-75</b>  <b>3760-125</b>  <b>3760-250</b>  <b>3768N-250</b>  <b>3769N-160</b>  <b>3770</b>  <b>3780</b>  <b>3785</b>  <b>3344A</b>



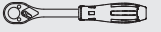

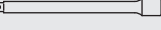
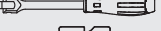
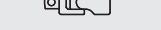
**3201AMW** Socket Set  
Steckschlüssel Satz  
Jeu de clés à douille



<b>3206AM</b> 27 Pieces Set/△=3,500g	
METAL CASE:W445xH190xT50mm	
Sockets	Accessories
<b>3405M</b> 12-pt. Sockets 7, 8, 10, 11, 12, 13, 14, 15, 16, 17, 19, 22 <b>3405A</b> 12-pt. Sockets 3/8, 7/16, 1/2, 9/16, 5/8, 11/16, 3/4, 13/16, 7/8 <b>3300C</b> Spark Plug Socket 20.8	 <b>3753J</b>  <b>3760-125</b>  <b>3760-250</b>  <b>3768J-250</b>  <b>3770</b>



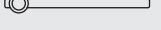

**3206AM** Socket Set  
Steckschlüssel Satz  
Jeu de clés à douille

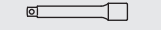

<b>3210M-00</b> 22 Pieces Set/△=2,900g <b>3210M-05</b> 22 Pieces Set/△=2,900g <b>3210M-10</b> 22 Pieces Set/△=2,900g	
METAL CASE:W360xH145xT50mm	
Sockets	Accessories
<b>(3210M-00)</b> <b>3400M</b> 6-pt. Sockets 6, 7, 8, 9, 10, 11, 12, 13, 14, 15, 16, 17, 18, 19, 21, 22 <b>(3210M-05)</b> <b>3405M</b> 12-pt. Sockets 6, 7, 8, 9, 10, 11, 12, 13, 14, 15, 16, 17, 18, 19, 21, 22 <b>(3210M-10)</b> <b>3410M</b> Surface Drive Sockets 6, 7, 8, 9, 10, 11, 12, 13, 14, 15, 16, 17, 18, 19, 21, 22	 <b>3753J</b>  <b>3760-125</b>  <b>3760-250</b>  <b>3768J-250</b>  <b>3770</b>  <b>3785</b>

**3210M-00 / 3210A-00** Socket Set  
Steckschlüssel Satz  
Jeu de clés à douille  
**3210M-05 / 3210A-05**  
**3210M-10**

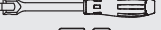

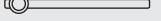
<b>3210A-00</b> 18 Pieces Set/△=2,760g <b>3210A-05</b> 18 Pieces Set/△=2,760g	
METAL CASE:W360xH145xT50mm	
Sockets	Accessories
<b>(3210A-00)</b> <b>3400A</b> 6-pt. Sockets 1/4, 5/16, 11/32, 3/8, 7/16, 1/2, 9/16, 5/8, 11/16, 3/4, 13/16, 7/8 <b>(3210A-05)</b> <b>3405A</b> 12-pt. Sockets 1/4, 5/16, 11/32, 3/8, 7/16, 1/2, 9/16, 5/8, 11/16, 3/4, 13/16, 7/8	 <b>3753J</b>  <b>3760-125</b>  <b>3760-250</b>  <b>3768J-250</b>  <b>3770</b>  <b>3785</b>

TORX® is a registered trademark of CAMCAR Innovations®.  
TORX® ist ein registriertes Markenzeichen der Firma CAMCAR Innovations®.  
TORX® est une marque déposée de CAMCAR Innovations®.

Z-SERIES  
HAND  
TITANIUM  
SCREWDRIVERS ACCESSORIES  
IMPACT  
SLEEVE-DRIVE  
PROTECTOR  
INDUSTRIAL  
AUTOMOTIVE  
MOTORCYCLE  
CONSTRUCTION  
SPARE PART

**3216** Spark Plug Sockets Set  
Zündkerzen-Schlüssel Satz  
Jeu de douilles pour bougies



3216		4 Pieces Set/△=730g	
PLASTIC BAG			
Sockets		Accessories	
	<b>3300C</b> Spark Plug Sockets 16, 20.8		<b>3760-125</b>
			<b>3774JL</b>

**3217M-00** Socket Set  
Steckschlüssel Satz  
Jeu de clés à douille

**3217M-05**

**3217M-10**

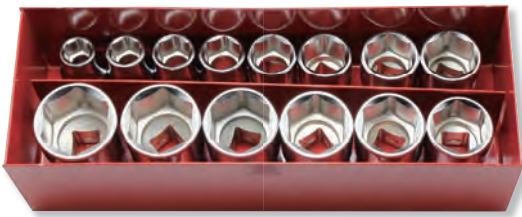

3217M-00		14 Pieces Set/△=850g	
3217M-05		14 Pieces Set/△=850g	
3217M-10		14 Pieces Set/△=850g	
METAL CASE:W168xH60xT42mm			
Sockets			
	(3217M-00) <b>3400M</b> 6-pt. Sockets 9, 10, 11, 12, 13, 14, 15, 16, 17, 18, 19, 20, 21, 22		
	(3217M-05) <b>3405M</b> 12-pt. Sockets 9, 10, 11, 12, 13, 14, 15, 16, 17, 18, 19, 20, 21, 22		
	(3217M-10) <b>3410M</b> Surface Drive Sockets 9, 10, 11, 12, 13, 14, 15, 16, 17, 18, 19, 20, 21, 22		

**3250M-00** Socket Set  
Steckschlüssel Satz  
Jeu de clés à douille





**3250M-05**



3250M-00		17 Pieces Set/△=2,200g	
3250M-05		17 Pieces Set/△=2,200g	
METAL CASE:W415xH120xT50mm			
Sockets		Accessories	
	<b>3400M</b> 6-pt. Sockets 7, 8, 10, 11, 12, 13, 14, 15, 16, 17, 18, 19		<b>3753J</b>
	<b>3405M</b> 12-pt. Sockets 7, 8, 10, 11, 12, 13, 14, 15, 16, 17, 18, 19		<b>3760-125</b>
			<b>3760-250</b>
			<b>3770</b>
			<b>3785</b>

**3251** 8 Pieces Set/△=675g

METAL CASE:W160xH100xT28mm

Sockets	Accessories
 <b>3025.50 TORX® Bit Sockets</b> T25H, T30H, T40H, T45H, T50H	 <b>2774PS-3/8</b>
	 <b>3763-50</b>
	 <b>3756</b>







**3251**

Bit Socket Set  
Schraubendreher-Steckschlüssel Satz  
Jeu de douilles de vissage



**3252M** 15 Pieces Set/△=1,530g

METAL CASE:W310xH90xT48mm

Sockets	Accessories
 <b>3400M 6-pt. Sockets</b> 5.5, 7, 8, 10, 11, 12	 <b>3753P</b>
 <b>3405M 12-pt. Sockets</b> 13, 14, 17, 19, 22	 <b>3760-75</b>
	 <b>3760-125</b>
	 <b>3770</b>









**3252M**

Socket Set  
Steckschlüssel Satz  
Jeu de clés à douille



**3275** 24 Pieces Set/△=3,150g

METAL CASE:W400xH147xT50mm

Sockets	Accessories
 <b>3400M 6-pt. Sockets</b> 6, 7, 8, 9, 10, 11, 12	 <b>3753J</b>
 <b>3405M 12-pt. Sockets</b> 13, 14, 15, 16, 17, 18, 19, 21, 22	 <b>3760-125</b>
 <b>3300C Spark Plug Sockets</b> 16, 20.8	 <b>3760-250</b>
	 <b>3768J-250</b>
	 <b>3770</b>
	 <b>3756</b>







**3275**

Socket Set  
Steckschlüssel Satz  
Jeu de clés à douille

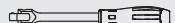

**3277** 29 Pieces Set/△=3,240g

METAL CASE:W370xH150xT50mm

Sockets	Accessories
 <b>3400M 6-pt. Sockets</b> 8, 9, 10, 11, 12	 <b>3753J</b>
 <b>3405M 12-pt. Sockets</b> 13, 14, 15, 16, 17, 18, 19, 21	 <b>3760-125</b>
 <b>3300M 6-pt. Deep Sockets</b> 8, 9, 10, 11, 12	 <b>3768J-250</b>
 <b>3305M 12-pt. Deep Sockets</b> 13, 14, 15, 16, 17, 18, 19, 21	







**3277**

Socket Set  
Steckschlüssel Satz  
Jeu de clés à douille



**3278** 20 Pieces Set/△=3,370g

METAL CASE:W310xH150xT50mm

Sockets	Accessories
 <b>3000 Bit Sockets</b> 2, 3	 <b>3753J</b>
 <b>3010M.62 Hex Bit Sockets</b> 5, 6, 7, 8, 10	 <b>3763-125</b>
 <b>3020.50 XZN Bit Sockets</b> M4, M5, M6, M8	
 <b>3025.50 TORX® Bit Sockets</b> T10, T15, T20, T25, T27, T30, T40	

**3278**

Bit Socket Set  
Schraubendreher-Steckschlüssel Satz  
Jeu de douilles de vissage



Z-SERIES  
HAND  
TITANIUM  
SCREWDRIVERS ACCESSORIES  
IMPACT  
SLEEVE-DRIVE  
PROTECTOR  
INDUSTRIAL  
AUTOMOTIVE  
CONSTRUCTION MOTORCYCLE  
SPARE PART

## 4401M 6-point Sockets 6-kant Steckschlüssel Douilles 6-pans



HANDY-ENDY®

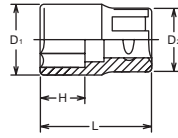

4401M 4406M (mm)	D <sub>1</sub> (mm)	D <sub>2</sub> (mm)	H (mm)	L (mm)	(g)	(pcs.)
8	13.2	22	8	36	44	10
9	13.8	22	8.5	37	44	10
10	15.3	22	9	37	45	10
11	16.5	22	9.5	37	46	10
12	17.8	22	10	37	47	10
13	19	22	10.5	37	53	10
14	20.3	22	11	37	56	10
15	21.5	22	11.5	37	52	10
16	22.8	22	12	37	62	10
17	24	22	12.5	37	69	10
18	25	23	13	37	74	10
19	26.5	24.5	14	38	89	10
20	27.8	26	15	38	92	10
21	29	27	15.5	38	102	10
22	30	28	16	40	113	10
23	31.5	29	16.5	40	128	10
24	32.8	30	17	42	140	5
25	34	31	18	42	164	5
26	35	32	19	42	165	5
27	36.5	33	19.5	43	196	5
28	37.8	34	20	43	198	5
29	39	35	20.5	43	190	5
30	40	36	22	46	222	5
31	41.5	37	22.5	46	257	5
32	42.8	38	23	46	250	5

## 4406M 12-point Sockets 12-kant Steckschlüssel Douilles 12-pans



HANDY-ENDY®

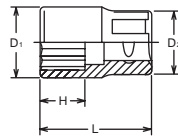

## 4400M 6-point Sockets 6-kant Steckschlüssel Douilles 6-pans

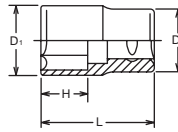

4400M 4405M (mm)	D <sub>1</sub> (mm)	D <sub>2</sub> (mm)	H (mm)	L (mm)	(g)	(pcs.)
33	44.2	39	24	47	275	5
34	45.2	40	24	47	315	5
35	46.2	40	24	47	317	5
36	47.2	41	24	47	336	5
37	48.3	42	24	47	360	5
38	49.2	43	24	47	380	5
41	53.1	45	29	57	471	5
46	59.1	48	32	60	567	2

## 4405M 12-point Sockets 12-kant Steckschlüssel Douilles 12-pans

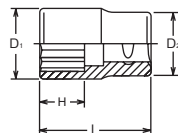

## RS4401M/10 Socket Set on Rail Steckschlüsselsatz auf Schiene Jeu de douilles sur rail



RS4401M/10	10 Pieces Set/Rail 300mm	(g)
10, 11, 12, 13, 14, 15, 16, 17, 18, 19		720

## RS4406M/10 Socket Set on Rail Steckschlüsselsatz auf Schiene Jeu de douilles sur rail



RS4406M/10	10 Pieces Set/Rail 300mm	(g)
10, 11, 12, 13, 14, 15, 16, 17, 18, 19		720

4400A 4405A (inch)	D <sub>1</sub> (mm)	D <sub>2</sub> (mm)	H (mm)	L (mm)	(g)	(pcs.)
1/4	10.7	21	6	36	41	10
5/16	13.2	21	8	36	44	10
3/8	14.6	21	9	37	45	10
7/16	16.5	21	9.5	37	46	10
1/2	19	22	10.5	37	53	10
9/16	20.3	22	11	37	56	10
19/32	21.5	22	11.5	37	52	10
5/8	22.8	22	12	37	62	10
21/32	24	23	12.5	37	69	10
11/16	25	24	13	37	74	10
3/4	26.5	25	14	38	89	10
25/32	27.8	26	15	38	92	10
13/16	29	27	15.5	38	102	10
7/8	30	28	16	40	113	10
15/16	32.8	30	17	42	140	5
31/32	34	31	18	42	165	5
1	35	32	19	42	165	5
1. 1/16	36.5	33	19.5	43	180	5
1. 1/8	39	35	20.5	43	210	5
1. 3/16	40	36	22	46	222	5
1. 1/4	42.8	38	23	46	250	5
1. 5/16	44.2	39	24	47	275	5
1. 3/8	46.2	40	24	47	317	5
1. 7/16	47.2	41	24	47	336	5
1. 1/2	49.2	43	24	47	380	5

Hand Sockets  
Both, 6-pt. and 12-pt. openings, are equipped with Flat Drive Openings, transferring the turning power from the corners on the flanks of nuts and bolts.

Sowohl 6-kant als auch 12-kant Steckschlüssel bieten alle Vorteile der "Flat Drive" Öffnung, die die Greifzonen auf die Flächen von Schrauben und Muttern versetzt.

Aussi bien les douilles 6-pans que 12-pans présentent tous les avantages liés au profil FLATDRIVE qui applique la force de serrage aux faces de la vis ou de l'écrou.

## 4400A 6-point Sockets 6-kant Steckschlüssel Douilles 6-pans

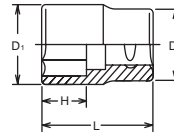

## 4405A 12-point Sockets 12-kant Steckschlüssel Douilles 12-pans

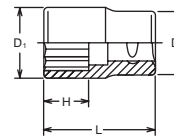

RS4400A/10	10 Pieces Set/Rail 300mm	(g)
3/8, 7/16, 1/2, 9/16, 5/8, 11/16, 3/4, 13/16, 7/8, 15/16		809

RS4405A/10	10 Pieces Set/Rail 300mm	(g)
3/8, 7/16, 1/2, 9/16, 5/8, 11/16, 3/4, 13/16, 7/8, 15/16		809

## RS4400A/10 Socket Set on Rail Steckschlüsselsatz auf Schiene Jeu de douilles sur rail



	6-Point	12-Point	Surface Drive	Nut Grip®	TORX® (E)	TORXPLUS® (EPL)	Tamper-Resistant TORXPLUS® (EPRL)	Double Square	LHSTIX® (LH-S)
1/4"	No. 2400M/A No. 2300M/A No. 2400W-BA No. 2300W-BA No. 2300X series	No. 2405M/A No. 2305M/A No. AS2405A No. AS2305A series	No. 2410M No. 3310M series	No. 2450MS/AS No. 2350M No. 2350X series	No. 2425 No. 2325 series	—	—	No. 2415M/A series	—
3/8"	No. 3400M/A No. 3300M/A No. 3400W No. 3300W No. 3300X/XA series	No. 3405M/A No. 3305M/A No. 3405W No. 3305W No. 3305X/XA series	No. 3410M No. 3310M series	No. 3450M/A No. 3450MH No. 3350M No. 3350X series	No. 3425 No. 3325 series	—	—	No. 3415M/A series	No. 3400LH series
1/2"	No. 4400M/A No. 4300M/A No. 4400W series	No. 4405M/A No. 4305M/A No. 4405W series	No. 4410M No. 4310M series	No. 4450M series	No. 4425 No. 4325 series	No. 4425-EPL series	No. 4425-EPRL series	—	No. 4400LH series

## 4410M

Surface Drive Sockets  
Surface Drive Steckschlüssel  
Douilles, Surface Drive

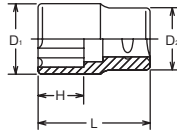

## RS4410M/10

Socket Set on Rail  
Steckschlüsselsatz auf Schiene  
Jeu de douilles sur rail



## SURFACE DRIVE

Surface drive sockets are designed to retain contact with the flat sides of the nut in order to transmit high torque and reduce nut wear. These sockets are ideal for using on polished nuts, aluminum nuts and nuts with worn out points.

Das Profil unserer Surface-Drive Steckschlüssel greift die Schraube an deren Flächen. Dies sichert eine höhere Kraftübertragung und verhindert ein Durchrutschen des Steckschlüssels. Diese Steckschlüssel eignen sich besonders für polierte Schrauben, Aluminiumschrauben und Schrauben bei denen die Ecken bereits abgerundet sind.

Notre profil Surface Drive assure le contact entre la douille et les plats de l'écrou. Ceci réduit l'usure et permet la transmission d'un couple plus élevé. C'est une solution idéale pour les écrous polies, celles en aluminium ou arrondies.

## 4400W

6-point Whitworth Sockets  
6-kant Steckschlüssel, Whitworth  
Douilles à 6-pans Whitworth

## 4405W

12-point Whitworth Sockets  
12-kant Steckschlüssel, Whitworth  
Douilles à 12-pans Whitworth

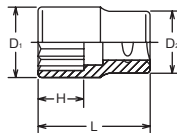

## RS4400W/8

Socket Set on Rail  
Steckschlüsselsatz auf Schiene  
Jeu de douilles sur rail



### BS W



BS · W	BS	3/16BS	1/4BS	5/16BS	3/8BS	7/16BS	1/2BS	9/16BS	5/8BS	11/16BS	3/4BS	7/8BS
	W	1/8W	3/16W	1/4W	5/16W	3/8W	7/16W	1/2W	9/16W	5/8W	11/16W	3/4W
	S (ref. mm)	8.64	11.30	13.34	15.24	18.03	20.83	23.37	25.65	27.94	30.48	33.35

## 4425-N

TORX® Sockets  
TORX® Steckschlüssel  
Douilles TORX®

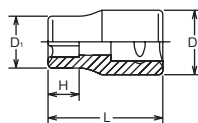

## RS4425/6-N

Socket Set on Rail  
Steckschlüsselsatz auf Schiene  
Jeu de douilles sur rail



4410M (mm)	D <sub>1</sub> (mm)	D <sub>2</sub> (mm)	H (mm)	L (mm)	(g)	(pcs.)
8	13.2	21	8	36	44	10
9	13.8	21	8.5	37	44	10
10	15.3	21	9	37	45	10
11	16.5	21	9.5	37	46	10
12	17.8	21	10	37	47	10
13	19	22	10.5	37	53	10
14	20.3	22	11	37	56	10
15	21.5	22	11.5	37	52	10
16	22.8	22	12	37	62	10
17	24	23	12.5	37	69	10
18	25	24	13	37	74	10
19	26.5	25	14	38	89	10
20	27.8	26	15	38	92	10
21	29	27	15.5	38	102	10
22	30	28	16	40	113	10
23	31.5	29	16.5	40	128	10
24	32.8	30	17	42	140	5
25	34	31	18	42	164	5
26	35	32	19	42	165	5
27	36.5	33	19.5	43	196	5
28	37.8	34	20	43	198	5
29	39	35	20.5	43	190	5
30	40	36	22	46	222	5
31	41.5	37	22.5	46	257	5
32	42.8	38	23	46	250	5
34	45.2	40	24	47	314	5

RS4410M/10	10 Pieces Set/Rail 300mm	(g)
10, 11, 12, 13, 14, 15, 17, 19, 21, 22		717

4400W / 4405W (W)	D <sub>1</sub> (mm)	D <sub>2</sub> (mm)	H (mm)	L (mm)	(g)	(pcs.)
3/16	16.5	21	9.5	37	46	10
1/4	19	22	10.5	37	54	10
5/16	21.5	22	11.5	37	54	10
3/8	25	24	13	37	73	10
7/16	29	27	15.5	38	87	10
1/2	31.5	29	16.5	40	133	10
9/16	35	32	19	42	165	5
5/8	37.8	34	20	43	191	5
11/16	40	36	22	46	222	5
3/4	44.2	39	24	47	280	5

RS4400W/8	8 Pieces Set/Rail 250mm	(g)
3/16, 1/4, 5/16, 3/8, 7/16, 1/2, 9/16, 5/8		860

RS4405W/8	8 Pieces Set/Rail 250mm	(g)
3/16, 1/4, 5/16, 3/8, 7/16, 1/2, 9/16, 5/8		860

4425 (E)	D <sub>1</sub> (mm)	D <sub>2</sub> (mm)	H (mm)	L (mm)	(g)	(pcs.)
E10N	13.2	21	8.2	36	47	10
E12N	14.6	21	9.3	37	48	10
E14N	16.5	21	10.6	37	50	10
E16N	19	22	11.8	37	60	10
E18N	20.3	22	13	37	60	10
E20N	22.8	22	14.4	37	65	10

TORX Socket for Nut and low profile bolt  
TORX-Steckschlüssel für Schrauben mit Flachprofil  
Douille TORX pour écrou et boulon à profil bas

Shallow Chamfer on Socket Opening

- A : Flywheel bolt MR20 NISSAN: 4425-E20N
- B : Cam sprocket FA20 for TOYOTA/SUBARU: 4425-E16N
- C : Connecting rod bolt FA20 for TOYOTA/SUBARU: 4425-E14N

RS4425/6-N	6 Pieces Set/Rail 200mm	(g)
E10N, E12N, E14N, E16N, E18N, E20N		370

TORX® is a registered trademark of CAMCAR Innovations®.  
TORX® ist ein registriertes Markenzeichen der Firma CAMCAR Innovations®.  
TORX® est une marque déposée de CAMCAR Innovations®.

4425 (E)	D <sub>1</sub> (mm)	D <sub>2</sub> (mm)	H (mm)	L (mm)	(g)	(pcs.)
E 8	10.7	21	7	36	41	10
E10	13.2	21	8.2	36	44	10
E11	13.8	21	8.7	37	45	10
E12	14.6	21	9.3	37	47	10
E14	16.5	21	10.6	37	48	10
E16	19	22	11.8	37	57	10
E18	20.3	22	13	37	57	10
E20	22.8	22	14.4	37	63	10
E22	25	24	15.5	37	78	10
E24	26.5	25	17	40	95	10

RS4425/7	7 Pieces Set/Rail 200mm	(g)
E10, E12, E14, E16, E18, E20, E24		428

### 4425 TORX® Sockets TORX® Steckschlüssel Douilles TORX®

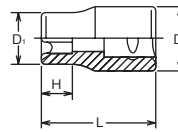

### RS4425/7 Socket Set on Rail Steckschlüsselsatz auf Schiene Jeu de douilles sur rail



### TORX® (E)

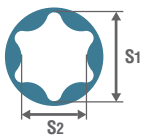

E	E4	E5	E6	E7	E8	E10	E11	E12	E14	E16	E18	E20	E22	E24	E26	E28	E30	E32
S <sub>1</sub> (ref. mm)	3.7	4.6	5.6	6.1	7.4	9.3	9.9	11.0	12.8	14.6	16.5	18.3	20.1	22.0	23.7	25.5	27.3	29.0
S <sub>2</sub> (ref. mm)	2.7	3.3	4.0	4.3	5.3	6.8	7.1	7.9	9.2	10.5	11.9	13.2	14.8	15.7	17.5	18.3	20.0	21.3

4425 (EPL)	D <sub>1</sub> (mm)	D <sub>2</sub> (mm)	H (mm)	L (mm)	(g)	(pcs.)
10EPL	13.2	21	6.2	36	45	10
12EPL	14.6	21	7.2	37	47	10
14EPL	16.5	21	8.1	37	49	10
16EPL	19	22	9.2	37	60	10
18EPL	20.3	22	10.2	37	60	10
20EPL	22.9	22	11.2	37	65	10

RS4425/6-EPL	6 Pieces Set/Rail 200mm	(g)
10EPL, 12EPL, 14EPL, 16EPL, 18EPL, 20EPL		390

### 4425 (EPL) TORXplus® Sockets TORXPLUS® Steckschlüssel Douilles TORXPLUS®

**TORXplus®**

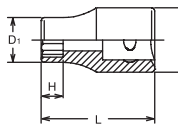

### RS4425/6-EPL Socket Set on Rail Steckschlüsselsatz auf Schiene Jeu de douilles sur rail



### TORXplus® (EP/EPL)

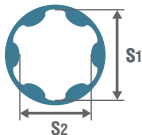

EP/EPL	7EP	8EP	10EP	12EP	14EP	16EP	18EP	20EP	22EP	24EP	26EP	28EP	30EP	32EP
S <sub>1</sub> (ref. mm)	6.1	7.4	9.3	11.0	12.8	14.6	16.5	18.3	20.1	22.0	23.7	25.5	27.3	29.0
S <sub>2</sub> (ref. mm)	4.7	5.7	7.1	8.5	9.8	11.2	12.7	14.0	15.4	16.8	18.2	19.6	20.9	22.3

4425 (EPRL)	D <sub>1</sub> (mm)	D <sub>2</sub> (mm)	H (mm)	L (mm)	(g)	(pcs.)
10EPRL	13.2	21	6.2	36	45	10
12EPRL	14.6	21	7.2	37	47	10
14EPRL	16.5	21	8.1	37	49	10
20EPRL	22.9	22	11.2	37	65	10

### 4425 (EPRL) Tamper-Resistant TORXPLUS® Sockets Tamper-Resistant TORXPLUS® Steckschlüssel Douilles Tamper-Resistant TORXPLUS®

**TORXplus®**

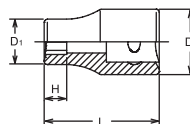

TORX® is a registered trademark of CAMCAR Innovations®.  
TORX® ist ein registriertes Markenzeichen der Firma CAMCAR Innovations®.  
TORX® est une marque déposée de CAMCAR Innovations®.

TORXplus® is a registered trademark of CAMCAR Innovations®.  
TORXplus® ist ein registriertes Markenzeichen der Firma CAMCAR Innovations®.  
TORXplus® est une marque déposée de CAMCAR Innovations®.

# Hand Sockets Hand Steckschlüssel Douilles à main

# 1/2"

Z-SERIES  
HAND  
TITANIUM  
SCREWDRIVERS  
ACCESSORIES  
IMPACT  
SLEEVE-DRIVE  
PROTECTOR  
INDUSTRIAL  
AUTOMOTIVE  
MOTORCYCLE  
CONSTRUCTION  
SPARE PART

## 4400LH

 LHSTIX® Sockets  
Steckschlüssel mit LHSTIX® Profil  
Douilles au profil LHSTIX®

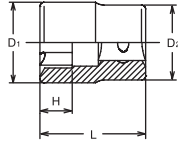

4400LH (LH-S)	D <sub>1</sub> (mm)	D <sub>2</sub> (mm)	H (mm)	L (mm)	(g)	(pcs.)
6S	13.2	21	5.6	36	44	10
8S	16.5	21	6.8	37	46	10
10S	19	22	8	37	53	10
12S	22.8	22	9.2	37	62	10
14S	25	24	10.4	37	74	10
16S	29	27	11.6	38	102	10

## RS4400LH/6

  Socket Set on Rail  
Steckschlüsselsatz auf Schiene  
Jeu de douilles sur rail



RS4400LH/6	6 Pieces Set/Rail 200mm	(g)
6S, 8S, 10S, 12S, 14S, 16S		430

### LHSTIX®

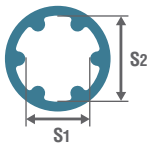

	LH-S	LH-5S	LH-6S	LH-8S	LH-10S	LH-12S	LH-14S	LH-16S
S <sub>1</sub>	(ref. mm)	5.6	6.8	9.0	11.3	13.6	15.8	18.1
S <sub>2</sub>	(ref. mm)	7.5	9.0	12.0	15.0	18.0	21.0	24.0

## 4450M

 Nut Grip Sockets **Nut Grip®**  
Steckschlüssel mit 2-facher Kugelhalterung  
Douilles à double billes de retenue

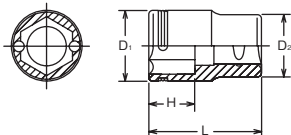

4450M (mm)	D <sub>1</sub> (mm)	D <sub>2</sub> (mm)	H (mm)	L (mm)	(g)	(pcs.)
10	15.3	21	6	36	44	10
11	16.5	21	6.5	36	46	10
12	17.8	21	7	36	46	10
13	19	22	8	36	52	10
14	20.3	22	8.5	36	54	10
15	21.5	22	9	36	52	10
16	22.8	22	9	36	60	10
17	24	23	9.5	36	68	10
18	25	24	10.5	36	77	10
19	26.5	25	11.5	36	85	10
21	29	27	12	37	110	10
22	30	28	12.5	37	105	10
24	32.8	30	14.5	39	130	5
27	36.5	33	16.5	40	139	5

## NUT GRIP®

Twin balls at the 6-point opening hold bolt/nut tightly for safe and reliable work.

Die zwei Kugeln in der 6-kant Öffnung unserer NUT GRIP Steckschlüssel halten die Schraube sicher im Steckschlüssel. Dies erlaubt ein Arbeiten auch an schwer zugänglichen Stellen.

Les 2 billes dans l'ouverture du 6-pans de la douille retiennent l'écrou de manière sûre et efficace.

## RS4450M/10

  Socket Set on Rail  
Steckschlüsselsatz auf Schiene  
Jeu de douilles sur rail



RS4450M/10	10 Pieces Set/Rail 300mm	(g)
10, 11, 12, 13, 14, 15, 17, 19, 21, 22		717

## 4300M / 4300A

6-point Deep Sockets  
6-kant Steckschlüssel, lang  
Douilles longues, 6-pans

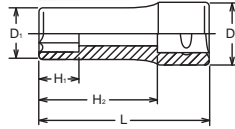

4300M 4305M (mm)	D <sub>1</sub> (mm)	D <sub>2</sub> (mm)	H <sub>1</sub> (mm)	H <sub>2</sub> (mm)	L (mm)	(g)	(pcs.)
8	13.2	21	9	59	77	76	10
9	13.8	21	10	59	77	82	10
10	15.3	21	11	59	77	82	10
11	16.5	21	12	59	77	86	10
12	17.8	21	13	59	77	92	10
13	19	21.8	14	59	77	106	10
14	20.3	21.8	15	59	77	115	10
15	21.5	21.8	16	59	77	123	10
16	22.8	22	17	59	77	141	10
17	24	23	18	59	77	139	10
18	25	24	19	59	77	149	10
19	26.5	25	20	58	77	165	10
20	27.8	26	21	58	77	183	10
21	29	27	23	58	77	190	10
22	30	28	27	57	77	200	10
23	31.5	29	27	57	77	233	10
24	32.8	30	27	57	77	249	10
25	34	31	27	57	77	270	10
26	35	32	27	56	77	279	10
27	36.5	33	28	56	77	303	10
28	37.8	34	28	56	77	331	10
29	39	35	28	55	77	357	10
30	40	36	34	55	77	342	10
31	41.5	37	34	55	77	384	10
32	42.8	38	34	55	77	405	10
33	44.2	39	35	54	77	420	5
34	45.2	40	35	54	77	442	5
35	46.2	40	35	53	77	458	5
36	47.2	41	35	53	77	484	5
37	48.2	42	38	53	77	475	5
38	49	44	38	53	77	490	5

## 4305M / 4305A

12-point Deep Sockets  
12-kant Steckschlüssel, lang  
Douilles longues, 12-pans

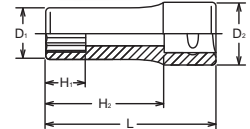

4300A 4305A (inch)	D <sub>1</sub> (mm)	D <sub>2</sub> (mm)	H <sub>1</sub> (mm)	H <sub>2</sub> (mm)	L (mm)	(g)	(pcs.)
5/16	13.2	21	9	59	77	76	10
3/8	14.6	21	10	59	77	82	10
7/16	16.5	21	12	59	77	86	10
1/2	19	21.8	14	59	77	106	10
9/16	20.3	21.8	15	59	77	115	10
19/32	21.5	21.8	16	59	77	123	10
5/8	22.8	22	17	59	77	141	10
21/32	24	23	18	59	77	139	10
11/16	25	24	19	59	77	149	10
3/4	26.5	25	20	58	77	165	10
25/32	27.8	26	21	58	77	183	10
13/16	29	27	23	58	77	190	10
7/8	30	28	27	57	77	200	10
15/16	32.8	30	27	57	77	249	10
31/32	34	31	27	57	77	270	10
1	35	32	27	56	77	279	10
1. 1/16	36.5	33	28	56	77	303	10
1. 1/8	37.8	34	28	56	77	331	10
1. 3/16	40	36	34	55	77	342	10
1. 1/4	42.8	38	34	55	77	405	10
1. 5/16	44.2	39	35	54	77	420	5
1. 3/8	46.2	40	35	54	77	422	5
1. 7/16	47.2	41	35	53	77	484	5
1. 1/2	49	44	38	53	77	523	5
1.13/16	59	48	38	51	77	791	2

RS4300M/10	10 Pieces Set/Rail 300mm	(g)
10, 11, 12, 13, 14, 15, 17, 19, 21, 22		1,415

RS4305M/10	10 Pieces Set/Rail 300mm	(g)
10, 11, 12, 13, 14, 15, 17, 19, 21, 22		1,415

RS4300M /12	12 Pieces Set/Rail 300mm	(g)
10, 12, 13, 14, 15, 16, 17, 18, 19, 20, 21, 22		1,825

RS4300A/10	10 Pieces Set/Rail 300mm	(g)
3/8, 7/16, 1/2, 9/16, 5/8, 11/16, 3/4, 13/16, 7/8, 15/16		1,600

RS4305A/10	10 Pieces Set/Rail 300mm	(g)
3/8, 7/16, 1/2, 9/16, 5/8, 11/16, 3/4, 13/16, 7/8, 15/16		1,600

## RS4300M/10



Socket Set on Rail  
Steckschlüsselsatz auf Schiene  
Jeu de douilles sur rail

## RS4305M/10



## RS4300M/12



Socket Set on Rail  
Steckschlüsselsatz auf Schiene  
Jeu de douilles sur rail



## RS4300A/10



Socket Set on Rail  
Steckschlüsselsatz auf Schiene  
Jeu de douilles sur rail

## RS4305A/10



# Hand Sockets Hand Steckschlüssel Douilles à main

# 1/2"

Z-SERIES  
HAND  
TITANIUM  
SCREWDRIVERS ACCESSORIES  
IMPACT  
SLEEVE-DRIVE  
PROTECTOR  
INDUSTRIAL  
AUTOMOTIVE  
CONSTRUCTION MOTORCYCLE  
SPARE PART

## 4310M

Surface Drive Deep Sockets  
Surface Drive Steckschlüssel, lang  
Douilles longues, Surface Drive

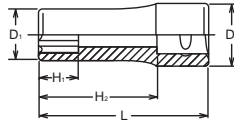
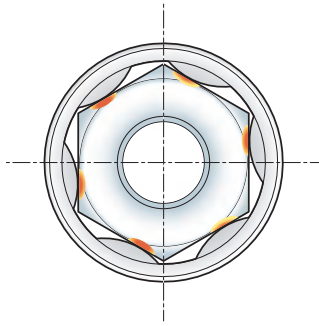

4310M (mm)	D <sub>1</sub> (mm)	D <sub>2</sub> (mm)	H <sub>1</sub> (mm)	H <sub>2</sub> (mm)	L (mm)	(g)	(pcs.)
8	13.2	21	9	59	77	79	10
9	13.8	21	10	59	77	82	10
10	15.3	21	11	59	77	82	10
11	16.5	21	12	59	77	86	10
12	17.8	21	13	59	77	92	10
13	19	21.8	14	59	77	106	10
14	20.3	21.8	15	59	77	115	10
15	21.5	21.8	16	59	77	123	10
16	22.8	22	17	59	77	141	10
17	24	23	18	59	77	139	10
18	25	24	19	59	77	149	10
19	26.5	25	20	58	77	165	10
20	27.8	26	21	58	77	183	10
21	29	27	23	58	77	190	10
22	30	28	27	57	77	200	10
23	31.5	29	27	57	77	233	10
24	32.8	30	27	57	77	249	10
25	34	31	27	57	77	270	10
26	35	32	27	56	77	279	10
27	36.5	33	28	56	77	303	10
28	37.8	34	28	56	77	334	10
29	39	35	28	55	77	357	10
30	40	36	34	55	77	342	10
31	41.5	37	34	55	77	384	10
32	42.8	38	34	55	77	405	10
34	45.2	40	35	54	77	442	5

## RS4310M/10

Socket Set on Rail  
Steckschlüsselsatz auf Schiene  
Jeu de douilles sur rail



RS4310M/10	10 Pieces Set/Rail 300mm	(g)
10, 11, 12, 13, 14, 15, 17, 19, 21, 22		1,415

## 4325

TORX® Deep Sockets  
TORX® Steckschlüssel, lang  
Douilles longues TORX®

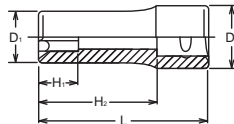

4325 (E)	D <sub>1</sub> (mm)	D <sub>2</sub> (mm)	H <sub>1</sub> (mm)	H <sub>2</sub> (mm)	L (mm)	(g)	(pcs.)
E 8	10.7	21	7	59	77	68	10
E10	13.2	21	8.2	59	77	99	10
E11	13.8	21	8.7	59	77	84	10
E12	14.6	21	9.3	59	77	99	10
E14	16.5	21	10.6	59	77	103	10
E16	19	21.8	11.8	59	77	107	10
E18	20.3	21.8	13	59	77	118	10
E20	22.8	22	14.4	59	77	141	10
E22	25	24	15.5	59	77	188	10
E24	26.6	25	17	59	77	215	10

## RS4325/7

Socket Set on Rail  
Steckschlüsselsatz auf Schiene  
Jeu de douilles sur rail



RS4325/7	7 Pieces Set/Rail 200mm	(g)
E10, E12, E14, E16, E18, E20, E24		900

### TORX® (E)

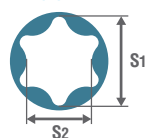

E	E4	E5	E6	E7	E8	E10	E11	E12	E14	E16	E18	E20	E22	E24	E26	E28	E30	E32
S <sub>1</sub> (ref. mm)	3.7	4.6	5.6	6.1	7.4	9.3	9.9	11.0	12.8	14.6	16.5	18.3	20.1	22.0	23.7	25.5	27.3	29.0
S <sub>2</sub> (ref. mm)	2.7	3.3	4.0	4.3	5.3	6.8	7.1	7.9	9.2	10.5	11.9	13.2	14.8	15.7	17.5	18.3	20.0	21.3

4300M(L120) (mm)	D <sub>1</sub> (mm)	D <sub>2</sub> (mm)	H <sub>1</sub> (mm)	H <sub>2</sub> (mm)	L (mm)	(g)	(pcs.)
8	13.2	21	9	102	120	120	5
10	15.3	21	11	102	120	138	5
12	17.8	21	13	102	120	157	5
14	20.3	21.8	15	102	120	193	5
16	22.8	22	17	102	120	210	5

## 4300M (L120) 6-point Extra Deep Sockets 6-kant Steckschlüssel, extra lang Douilles extra longues 6-pans

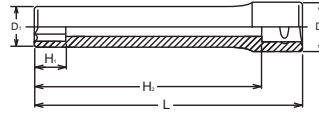

4325(L140) (E)	D <sub>1</sub> (mm)	D <sub>2</sub> (mm)	H <sub>1</sub> (mm)	H <sub>2</sub> (mm)	L (mm)	(g)	(pcs.)
E 8	10.7	21	7	122	140	110	5
E10	13.2	21	8.2	122	140	140	5
E12	14.6	21	9.3	122	140	160	5
E14	16.5	21	10.6	122	140	180	5

## 4325 (L140) TORX® Extra Deep Sockets TORX® Steckschlüssel, extra lang Douilles extra longues TORX®

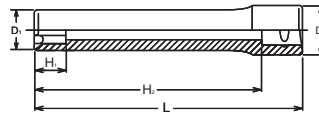

4325(L140) (E)	D <sub>1</sub> (mm)	D <sub>2</sub> (mm)	H <sub>1</sub> (mm)	H <sub>2</sub> (mm)	L (mm)	(g)	(pcs.)
E 8(2B)	10.7	21	6.6	122	140	110	5
E10(2B)	13.2	21	7.4	122	140	140	5
E12(2B)	14.6	21	9	122	140	160	5
E14(2B)	16.5	21	9.8	122	140	180	5

For Cylinder head bolt



## 4325 (L140)-2B TORX® Sockets Nut Grip® TORX® Steckschlüssel mit 2-facher Kugelhalterung Douilles TORX® à deux billes de retenue

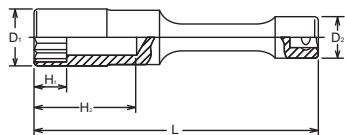
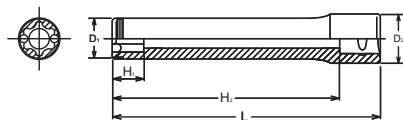

## 4117M-125 / -250 Extended Sockets Schافتsteckschlüssel Douilles rallongées



4117M-125 (mm)	D <sub>1</sub> (mm)	D <sub>2</sub> (mm)	H <sub>1</sub> (mm)	H <sub>2</sub> (mm)	L (mm)	(g)	(pce.)
13	18.7	24	13	59	125	213	1
14	20.2	24	14	59	125	227	1
17	24	24	17	59	125	274	1
19	26.9	24	19	59	125	279	1

4117M-250 (mm)	D <sub>1</sub> (mm)	D <sub>2</sub> (mm)	H <sub>1</sub> (mm)	H <sub>2</sub> (mm)	L (mm)	(g)	(pce.)
13	18.7	24	13	59	250	412	1
14	20.2	24	14	59	250	423	1
17	24	24	17	59	250	469	1
19	26.9	24	19	59	250	484	1

Z-SERIES  
HAND  
TITANIUM  
ACCESSORIES  
SCREWDRIVERS  
IMPACT  
SLEEVE-DRIVE  
PROTECTOR  
INDUSTRIAL  
AUTOMOTIVE  
MOTORCYCLE  
CONSTRUCTION  
SPARE PART

## 4440M / 4440A 6-point Universal Sockets 6-kant Gelenk-Einsätze Douilles articulées, 6-pans

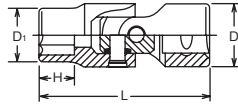

4440A (inch)	D <sub>1</sub> (mm)	D <sub>2</sub> (mm)	H (mm)	L (mm)	(g)	(pcs.)
3/8	14.8	25	8.8	63	155	10
7/16	16.5	25	10	65	158	10
1/2	19	25	11.4	66	152	10
9/16	20.3	25	11.4	66	151	10
5/8	22.8	25	13	68	150	10
11/16	24.6	25	14	69	153	10
3/4	26.5	25	15	71	170	10
7/8	30.3	25	16	72	185	5

4440M (mm)	D <sub>1</sub> (mm)	D <sub>2</sub> (mm)	H (mm)	L (mm)	(g)	(pcs.)
9	14	25	8.3	63	150	10
10	15.3	25	8.8	63	155	10
11	16.5	25	10	65	158	10
12	17.8	25	10.5	65	151	10
13	19	25	11.4	66	152	10
14	20.3	25	11.4	66	151	10
15	21.5	25	13	68	149	10
16	22.8	25	13	68	150	10
17	24	25	14	69	150	10
18	25.3	25	14	69	150	10
19	26.5	25	15	71	170	10
20	27.8	25	15	71	173	5
21	29	25	16	72	176	5
22	30.3	25	16	72	185	5

## 4445M / 4445A 12-point Universal Sockets 12-kant Gelenk-Einsätze Douilles articulées, 12-pans

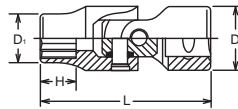

4445A (inch)	D <sub>1</sub> (mm)	D <sub>2</sub> (mm)	H (mm)	L (mm)	(g)	(pcs.)
3/8	14.8	25	8.8	63	155	10
7/16	16.5	25	10	65	158	10
1/2	19	25	11.4	66	152	10
9/16	20.3	25	11.4	66	151	10
5/8	22.8	25	13	68	150	10
11/16	24.6	25	14	69	153	10

4445M (mm)	D <sub>1</sub> (mm)	D <sub>2</sub> (mm)	H (mm)	L (mm)	(g)	(pcs.)
10	15.3	25	8.8	63	155	10
12	17.8	25	10.5	65	151	10
13	19	25	11.4	66	152	10
14	20.3	25	11.4	66	151	10
17	24	25	14	69	150	10
19	26.5	25	15	71	170	10
21	29	25	16	72	176	5
22	30.3	25	16	72	185	5

## 4440T TORX® Universal Sockets TORX® Gelenk-Einsätze Douilles articulées, TORX®

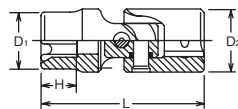

4440T (E)	D <sub>1</sub> (mm)	D <sub>2</sub> (mm)	H (mm)	L (mm)	(g)	(pcs.)
E10	13.2	25	8.2	62	145	10
E12	15	25	9.3	63	147	10
E14	16.3	25	10.6	65	148	10
E16	18.8	25	11.8	65	150	10
E18	20.4	25	13	67	153	10

## 4000-60 (PH) PH Bit Sockets Steckschlüssel für Kreuzschlitzschrauben, PH Douilles tournevis pour vis à empreinte PH

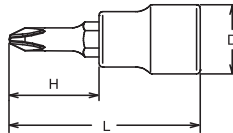

4000 (PH)	D (mm)	H (mm)	L (mm)	(g)	(pcs.)
2	22	23.5	60	65	10
3	22	23.5	60	65	10
4	22	23.5	60	67	10

## 4000-60 (PZ) PZ Bit Sockets Steckschlüssel für Kreuzschlitzschrauben, PZ Douilles tournevis pour vis à empreinte PZ

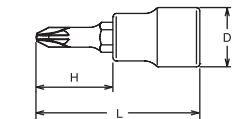

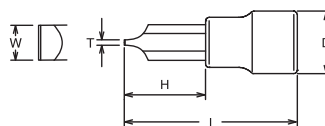

4000-60 (PZ)	D (mm)	H (mm)	L (mm)	(g)	(pcs.)
PZ2	22	23.5	60	65	10
PZ3	22	23.5	60	65	10

## 4005-60 Bit Sockets for Slotted Heads Steckschlüssel für Schlitzschrauben Douilles tournevis pour vis à fente



4005	TxW (mm)	D (mm)	H (mm)	L (mm)	(g)	(pcs.)
8	1.2x 8	22	23.5	60	65	10
10	1.6x10	22	23.5	60	75	10
12	2.0x12	23	23.5	60	111	10
14	2.5x14	24	23.5	60	133	10
16	2.5x16	24	23.5	60	133	10

## 4010M-50 / -75 / -100 / -160 4010A-60

 Inhex Bit Sockets  
Steckschlüssel für Innexschkant-Schrauben  
 Douilles tournevis pour vis 6-pans creux

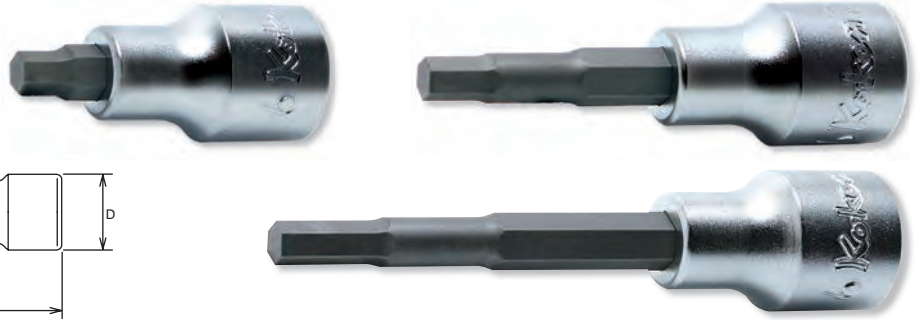

4010M-50 (mm)	D (mm)	H <sub>1</sub> (mm)	H <sub>2</sub> (mm)	L (mm)	⚖️ (g)	📦 (pcs.)
4	22	5	13.5	50	61	10
5	22	5	13.5	50	62	10
6	22	6	13.5	50	64	10
7	22	7	13.5	50	65	10
8	22	-	13.5	50	66	10
9	22	8	13.5	50	73	10
10	22	-	13.5	50	75	10
12	23	-	13.5	50	105	10
13	24	8.5	13.5	50	120	10
14	24	-	13.5	50	120	10
16	25	8.5	15	50	150	10
17	25	-	15	50	150	10
18	27	8.5	15	50	200	5
19	27	-	15	50	200	5

4010M-75 (mm)	D (mm)	H <sub>1</sub> (mm)	H <sub>2</sub> (mm)	L (mm)	⚖️ (g)	📦 (pcs.)
4	22	8.5	38.5	75	69	10
5	22	8.5	38.5	75	70	10
6	22	8.5	38.5	75	72	10
7	22	8.5	38.5	75	73	10
8	22	-	38.5	75	74	10
9	22	8.5	38.5	75	90	10
10	22	-	38.5	75	92	10
12	23	-	38.5	75	130	10
13	24	8.5	38.5	75	150	10
14	24	-	38.5	75	150	10
16	25	8.5	35	75	180	10
17	25	-	35	75	180	10
18	27	8.5	33	75	230	5
19	27	-	33	75	230	5

4010M-100 (mm)	D (mm)	H <sub>1</sub> (mm)	H <sub>2</sub> (mm)	L (mm)	⚖️ (g)	📦 (pcs.)
4	22	8.5	63.5	100	77	10
5	22	8.5	63.5	100	78	10
6	22	8.5	63.5	100	80	10
7	22	8.5	63.5	100	82	10
8	22	-	63.5	100	84	10
9	22	8.5	63.5	100	105	10
10	22	-	63.5	100	109	10
12	23	-	63.5	100	155	10
13	24	8.5	63.5	100	180	5
14	24	-	63.5	100	180	5
16	25	8.5	60	100	250	5
17	25	-	60	100	250	5
18	27	8.5	58	100	300	5
19	27	-	58	100	300	5

4010M-160 (mm)	D (mm)	H <sub>1</sub> (mm)	H <sub>2</sub> (mm)	L (mm)	⚖️ (g)	📦 (pcs.)
4	22	8.5	123.5	160	103	10
5	22	8.5	123.5	160	104	10
6	22	8.5	123.5	160	106	10
7	22	8.5	123.5	160	108	10
8	22	-	123.5	160	110	10
10	22	-	123.5	160	126	10
12	23	-	123.5	160	180	5
14	24	-	123.5	160	260	5
17	25	-	120	160	360	5
19	27	-	118	160	415	5

4010A-60 (inch)	D (mm)	H <sub>1</sub> (mm)	H <sub>2</sub> (mm)	L (mm)	⚖️ (g)	📦 (pcs.)
5/32	22	8.5	23.5	60	57	10
3/16	22	8.5	23.5	60	57	10
7/32	22	8.5	23.5	60	59	10
1/4	22	8.5	23.5	60	63	10
9/32	22	8.5	23.5	60	65	10
5/16	22	-	23.5	60	67	10
11/32	22	8.5	23.5	60	75	10
3/8	22	8.5	23.5	60	76	10
7/16	23	8.5	23.5	60	101	10
1/2	24	8.5	23.5	60	124	10
9/16	25	-	20	60	127	10
5/8	25	-	20	60	174	10
3/4	27	-	18	60	220	5





RS4010M/10-L50	10 Pieces Set/Rail 300mm	⚖️ (g)
4, 5, 6, 7, 8, 10, 12, 14, 17, 19		968

RS4010M/10-L75	10 Pieces Set/Rail 300mm	⚖️ (g)
4, 5, 6, 7, 8, 10, 12, 14, 17, 19		1,207

RS4010A/10-L60	10 Pieces Set/Rail 300mm	⚖️ (g)
3/16, 7/32, 1/4, 5/16, 3/8, 7/16, 1/2, 9/16, 5/8, 3/4		1,080

**RS4010M/10-L50**  Socket Set on Rail  
Steckschlüsselsatz auf Schiene  
Jeu de douilles sur rail

**RS4010M/10-L75** 

**RS4010A/10-L60** 



# Hand Sockets Hand Steckschlüssel 1/2" Douilles à main

## 4012M-43 / -60 / -75 / -100



Inhex Sockets  
Steckschlüssel für Innensechskant-Schrauben ⚠  
Douilles tournevis pour vis 6-pans creux

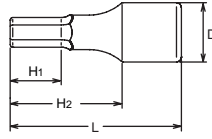

4012M-43 (mm)	D (mm)	H <sub>1</sub> (mm)	H <sub>2</sub> (mm)	L (mm)	(g)	(pcs.)
4	21.1	11.5	23	43	40	10
5	21.1	11.5	23	43	46	10
6	21.1	11.5	23	43	42	10
7	21.1	11.5	23	43	46	10
8	21.1	11.5	23	43	49	10
9	21.1	11.5	23	43	63	10
10	23	11.5	23	43	63	10
11	25	11.5	23	43	74	10
12	25	11.5	23	43	81	10
13	25	11.5	23	43	85	10
14	25	11.5	23	43	88	10
15	26	11.5	23	43	91	10
16	26	11.5	23	43	100	10
17	26	11.5	23	43	101	10
18	26	11.5	23	43	106	10
19	26	11.5	23	43	110	10
20	26	11.5	23	43	130	10
21	26	11.5	23	43	140	10
22	26	11.5	23	43	145	10
23	28	11.5	23	43	167	10
24	28	11.5	23	43	170	10
27	32	11.5	23	43	226	10

4012M-60 (mm)	D (mm)	H <sub>1</sub> (mm)	H <sub>2</sub> (mm)	L (mm)	(g)	(pcs.)
4	21.1	15.5	38	60	49	10
5	21.1	15.5	38	60	55	10
6	21.1	15.5	38	60	56	10
7	21.1	15.5	38	60	60	10
8	21.1	15.5	38	60	64	10
9	21.1	15.5	38	60	78	10
10	23	15.5	38	60	78	10
11	25	15.5	38	60	100	10
12	25	15.5	38	60	107	10
13	25	15.5	38	60	111	10
14	25	15.5	38	60	122	10
15	26	15.5	38	60	125	10
16	26	15.5	38	60	134	10
17	26	15.5	38	60	141	10
18	26	15.5	38	60	153	10
19	26	15.5	38	60	159	10
21	26	15.5	38	60	197	10
22	26	22.5	38	60	205	10
23	28	22.5	38	60	242	10
24	28	22.5	38	60	245	10

4012M-75 (mm)	D (mm)	H <sub>1</sub> (mm)	H <sub>2</sub> (mm)	L (mm)	(g)	(pcs.)
4	21.1	15.5	53	75	52	10
5	21.1	15.5	53	75	58	10
6	21.1	15.5	53	75	62	10
7	21.1	15.5	53	75	70	10
8	21.1	15.5	53	75	74	10
9	21.1	15.5	53	75	88	10
10	23	15.5	53	75	94	10
11	25	15.5	53	75	119	10
12	25	15.5	53	75	122	10
13	25	15.5	53	75	137	10
14	25	15.5	53	75	148	10
15	26	15.5	53	75	151	10
16	26	15.5	53	75	171	10
17	26	15.5	53	75	184	10
18	26	15.5	53	75	196	10
19	26	15.5	53	75	212	10
22	26	22.5	53	75	266	10
24	27.9	22.5	53	75	315	10

4012M-100 (mm)	D (mm)	H <sub>1</sub> (mm)	H <sub>2</sub> (mm)	L (mm)	(g)	(pcs.)
4	24	15.5	78	100	75	10
5	24	15.5	78	100	81	10
6	24	15.5	78	100	85	10
7	24	15.5	78	100	93	10
8	24	15.5	78	100	97	10
9	24	15.5	78	100	111	10
10	24	15.5	78	100	117	10
11	24	15.5	78	100	142	10
12	24	15.5	78	100	143	10
13	24	15.5	78	100	158	10
14	24	15.5	78	100	169	10
15	24	15.5	78	100	172	10
16	24	15.5	78	100	192	5
17	24	15.5	78	100	215	5
18	24	15.5	78	100	227	5
19	24	15.5	78	100	243	5

## RS4012M/10-L60



Socket Set on Rail  
Steckschlüsselsatz auf Schiene  
Jeu de douilles sur rail



RS4012M/10-L60

10 Pieces set/Rail 300mm





4, 5, 6, 7, 8, 10, 12, 14, 17, 19

910



4012M/A are for hand use only.  
Do not use with a power or impact wrench.  
Nicht mit elektrischen/maschinellen Schraubern verwenden.  
À ne pas utiliser sur des machines

## 4012A-43 / -60 / -75 / -100

 Inhex Sockets  
Steckschlüssel für Innensechskant-Schrauben   
Douilles tournevis pour vis 6-pans creux

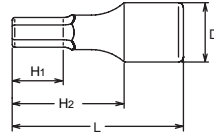

4012A-43 (inch)	D (mm)	H <sub>1</sub> (mm)	H <sub>2</sub> (mm)	L (mm)	(g)	(pcs.)
5/32	21.1	11.5	23	43	40	10
3/16	21.1	11.5	23	43	46	10
7/32	21.1	11.5	23	43	42	10
1/4	21.1	11.5	23	43	43	10
9/32	21.1	11.5	23	43	46	10
5/16	21.1	11.5	23	43	49	10
11/32	21.1	11.5	23	43	63	10
3/8	23	11.5	23	43	59	10
7/16	25	11.5	23	43	74	10
1/2	25	11.5	23	43	85	10
9/16	25	11.5	23	43	88	10
5/8	26	11.5	23	43	100	10
3/4	26	11.5	23	43	110	10
7/8	26	11.5	23	43	141	10

4012A-60 (inch)	D (mm)	H <sub>1</sub> (mm)	H <sub>2</sub> (mm)	L (mm)	(g)	(pcs.)
5/32	21.1	15.5	38	60	49	10
3/16	21.1	15.5	38	60	55	10
7/32	21.1	15.5	38	60	56	10
1/4	21.1	15.5	38	60	57	10
9/32	21.1	15.5	38	60	60	10
5/16	21.1	15.5	38	60	64	10
11/32	21.1	15.5	38	60	78	10
3/8	23	15.5	38	60	74	10
7/16	25	15.5	38	60	100	10
1/2	25	15.5	38	60	111	10
9/16	25	15.5	38	60	122	10
5/8	26	15.5	38	60	134	10
3/4	26	15.5	38	60	159	10
7/8	26	22.5	38	60	202	10

4012A-75 (inch)	D (mm)	H <sub>1</sub> (mm)	H <sub>2</sub> (mm)	L (mm)	(g)	(pcs.)
5/32	21.1	15.5	53	75	52	10
3/16	21.1	15.5	53	75	58	10
7/32	21.1	15.5	53	75	62	10
1/4	21.1	15.5	53	75	65	10
9/32	21.1	15.5	53	75	70	10
5/16	21.1	15.5	53	75	74	10
11/32	21.1	15.5	53	75	88	10
3/8	23	15.5	53	75	86	10
7/16	25	15.5	53	75	119	10
1/2	25	15.5	53	75	137	10
9/16	25	15.5	53	75	148	10
5/8	26	15.5	53	75	171	10
3/4	26	15.5	53	75	212	10
7/8	26	22.5	53	75	262	10

4012A-100 (inch)	D (mm)	H <sub>1</sub> (mm)	H <sub>2</sub> (mm)	L (mm)	(g)	(pcs.)
5/32	24	15.5	78	100	75	10
3/16	24	15.5	78	100	81	10
7/32	24	15.5	78	100	85	10
1/4	24	15.5	78	100	88	10
9/32	24	15.5	78	100	93	10
5/16	24	15.5	78	100	97	10
11/32	24	15.5	78	100	111	10
3/8	24	15.5	78	100	109	10
7/16	24	15.5	78	100	142	10
1/2	24	15.5	78	100	158	10
9/16	24	15.5	78	100	169	10
5/8	24	15.5	78	100	192	5
3/4	24	15.5	78	100	243	5

RS4012A/10-L60	10 Pieces set/Rail 300mm	(g)
3/16, 7/32, 1/4, 5/16, 3/8, 7/16, 1/2, 9/16, 5/8, 3/4		950

**RS4012A/10-L60**   Socket Set on Rail  
Steckschlüsselsatz auf Schiene  
Jeu de douilles sur rail



 4012M/A are for hand use only.  
Do not use with a power or impact wrench.  
Nicht mit elektrischen/maschinellen Schraubern verwenden.  
À ne pas utiliser sur des machines

# Hand Sockets Hand Steckschlüssel Douilles à main

# 1/2"

Z-SERIES  
HAND  
TITANIUM  
SCREWDRIVERS ACCESSORIES  
IMPACT  
SLEEVE-DRIVE  
PROTECTOR  
INDUSTRIAL  
AUTOMOTIVE  
CONSTRUCTION MOTORCYCLE  
SPARE PART

## 4020-60 / -100 / -120 / -140

 XZN Bit Sockets  
Steckschlüssel für XZN Schrauben  
Douilles tournevis pour empreinte XZN

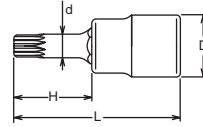

4020-60 (XZN)	D (mm)	d (mm)	H (mm)	L (mm)	(g)	(pcs.)
M 5	22	7.8	23.5	60	60	10
M 6	22	7.8	23.5	60	61	10
M 8	22	7.8	23.5	60	63	10
M10	23	11.9	23.5	60	93	10
M12	23	11.9	23.5	60	97	10
M14	24	13.9	23.5	60	105	10
M16	25	16.9	20	60	165	10
M18	25	17.9	20	60	170	5

4020-120 (XZN)	D (mm)	d (mm)	H (mm)	L (mm)	(g)	(pcs.)
M 5	22	7.8	83.5	120	86	10
M 6	22	7.8	83.5	120	87	10
M 8	22	7.8	83.5	120	89	10
M10	23	11.9	83.5	120	152	10
M12	23	11.9	83.5	120	156	10
M14	24	13.9	83.5	120	164	5

4020-100 (XZN)	D (mm)	d (mm)	H (mm)	L (mm)	(g)	(pcs.)
M 5	22	7.8	63.5	100	77	10
M 6	22	7.8	63.5	100	78	10
M 8	22	7.8	63.5	100	80	10
M10	23	11.9	63.5	100	132	10
M12	23	11.9	63.5	100	136	10
M14	24	13.9	63.5	100	144	5
M16	25	16.9	60	100	250	5
M18	27	17.9	60	100	300	5

4020-140 (XZN)	D (mm)	d (mm)	H (mm)	L (mm)	(g)	(pcs.)
M 5	22	7.8	103.5	140	95	10
M 6	22	7.8	103.5	140	96	10
M 8	22	7.8	103.5	140	98	10
M10	23	11.9	103.5	140	172	5
M12	23	11.9	103.5	140	176	5
M14	24	13.9	103.5	140	184	5

## RS4020/6-L60 RS4020/6-L100

 Socket Set on Rail  
Steckschlüsselsatz auf Schiene  
Jeu de douilles sur rail



RS4020/6-L60	6 Pieces Set/Rail 150mm	(g)
<b>M5, M6, M8, M10, M12, M14</b>		500







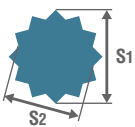



  

RS4020/6-L100	6 Pieces Set/Rail 150mm	(g)
<b>M5, M6, M8, M10, M12, M14</b>		680

### XZN



XZN		M4	M5	M6	M8	M10	M12	M14	M16	M18
S <sub>1</sub>	(ref. mm)	3.6	4.8	6.1	7.3	9.7	11.5	13.3	15.7	16.9
S <sub>2</sub>	(ref. mm)	3.1	4.1	5.1	6.1	8.1	9.7	11.2	13.2	14.2

	 PH	 PZ	 Slotted	 HEX	 HEX (ball point)	 Triple Square (XZN)	 TORX® (T)	 TORX® (TH)	 TORXplus® (IP)	 TORXplus® (IPR)	 Ribe-CV
1/4"	No.2000 series	No.2000(PZ) series	No.2005 series	No.2010M/A series	No.2011M series	No.2020 series	No.2025 series	No.2025(TH) series	No.2025(IP) series	No.2025(IPR) series	—
3/8"	No.3000 series	No.3000(PZ) series	No.3005 series	No.3010M/A No.3012M/A No.3015M series	No.3011M series	No.3020 series	No.3025 series	No.3025(TH) series	No.3025(IP) series	No.3025(IPR) series	No.3027 series
1/2"	No.4000 series	No.4000(PZ) series	No.4005 series	No.4010M/A No.4012M/A series	—	No.4020 series	No.4025 series	—	No.4025(IP) series	—	No.4027 series

4025-60 (T)	D (mm)	H (mm)	L (mm)	(g)	(pcs.)
T15	22	23.5	60	58	10
T20	22	23.5	60	59	10
T25	22	23.5	60	60	10
T27	22	23.5	60	60	10
T30	22	23.5	60	60	10
T40	22	23.5	60	62	10
T45	22	23.5	60	64	10
T50	22	23.5	60	74	10
T55	23	23.5	60	96	10
T60	24	23.5	60	122	10
T70	24	23.5	60	135	10
T80	24	20	60	168	10

4025-100 (T)	D (mm)	H (mm)	L (mm)	(g)	(pcs.)
T20	22	73.5	100	76	10
T25	22	73.5	100	76	10
T27	22	73.5	100	77	10
T30	22	73.5	100	77	10
T40	22	73.5	100	78	10
T45	22	73.5	100	80	10
T50	22	73.5	100	98	10
T55	23	73.5	100	132	10
T60	24	73.5	100	170	5
T70	24	73.5	100	175	5

4025-140 (T)	D (mm)	H (mm)	L (mm)	(g)	(pcs.)
T20	22	103.5	140	94	10
T25	22	103.5	140	95	10
T27	22	103.5	140	95	10
T30	22	103.5	140	95	10
T40	22	103.5	140	97	10
T45	22	103.5	140	99	10
T50	22	103.5	140	129	10
T55	23	103.5	140	175	5
T60	24	103.5	140	229	5
T70	24	103.5	140	245	5
T80	24	100	140	320	5

RS4025/9-L60	9 Pieces Set/Rail 250mm	(g)
T20, T25, T27, T30, T40, T45, T50, T55, T60		700

## 4025-60 / -100 / -140 (T)

TORX® Bit Sockets  
TORX® Bit-Steckschlüssel  
Douilles tournevis, TORX®

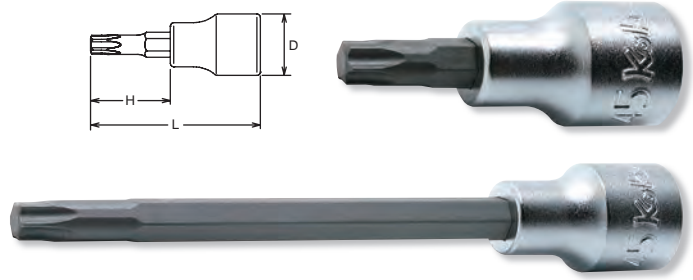

## RS4025/9-L60



Socket Set on Rail  
Steckschlüsselsatz auf Schiene  
Jeu de douilles sur rail



### TORX® (T)

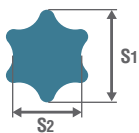

T		T8	T9	T10	T15	T20	T25	T27	T30	T40	T45	T50	T55	T60	T70	T80	T90	T100
S <sub>1</sub>	(ref. mm)	2.3	2.5	2.7	3.3	3.9	4.5	5.0	5.6	6.7	7.9	8.9	11.3	13.3	15.6	17.6	20.0	22.2
S <sub>2</sub>	(ref. mm)	1.7	1.8	2.0	2.3	2.8	3.2	3.6	4.0	4.8	5.6	6.2	8.0	9.5	11.1	12.7	14.2	15.8

4025-60	D (mm)	H (mm)	L (mm)	(g)	(pcs.)
T35	22	23.5	60	96	10

For T35 Special screws

## 4025-60-T35

Bit Socket  
Bit-Steckschlüssel  
Douilles tournevis



Z-SERIES  
HAND  
TITANIUM  
SCREWDRIVERS ACCESSORIES  
IMPACT  
SLEEVE-DRIVE  
PROTECTOR  
INDUSTRIAL  
AUTOMOTIVE  
CONSTRUCTION MOTORCYCLE  
SPARE PART

## 4025-60 / -100 (IP)

 TORXPLUS® Bit Sockets  
TORXPLUS® Bit-Steckschlüssel  
Douilles tournevis, TORXPLUS®

**TORXplus**



4025-60 (IP)	D (mm)	H (mm)	L (mm)	(g)	(pcs.)
20IP	22	23.5	60	60	10
25IP	22	23.5	60	60	10
27IP	22	23.5	60	60	10
30IP	22	23.5	60	60	10
40IP	22	23.5	60	60	10
45IP	22	23.5	60	64	10
50IP	22	23.5	60	74	10
55IP	23	23.5	60	96	10
60IP	24	23.5	60	122	10
70IP	24	23.5	60	170	10

## RS4025/9-IP

 Socket Set on Rail  
Steckschlüsselsatz auf Schiene  
Jeu de douilles sur rail



4025-100 (IP)	D (mm)	H (mm)	L (mm)	(g)	(pcs.)
40IP	22	63.5	100	79	10
45IP	22	63.5	100	81	10
50IP	22	63.5	100	100	10
55IP	23	63.5	100	133	10
60IP	24	63.5	100	172	5
70IP	25	63.5	100	241	5

RS4025/9-IP	9 Pieces set/Rail 250mm	(g)
20IP, 25IP, 27IP, 30IP, 40IP, 45IP, 50IP, 55IP, 60IP		700

### TORXPLUS® (IP)

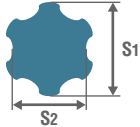

IP	8IP	9IP	10IP	15IP	20IP	25IP	27IP	30IP	40IP	45IP	50IP	55IP	60IP	70IP
S <sub>1</sub> (ref. mm)	2.3	2.5	2.7	3.3	3.9	4.5	5.0	5.6	6.7	7.9	8.9	11.3	13.3	15.6
S <sub>2</sub> (ref. mm)	1.8	1.9	2.1	2.5	3.0	3.4	3.9	4.3	5.2	6.2	6.9	9.0	10.4	12.3

## 4027-60 / -100 / -140

 Bit Sockets for Ribe Screws  
Steckschlüsselsklingen für Ribe Schrauben  
Douilles tournevis pour écrous profil Ribe

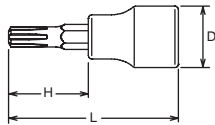

4027-60	D (mm)	H (mm)	L (mm)	(g)	(pcs.)
M 5	22	23.5	60	60	10
M 6	22	23.5	60	62	10
M 7	22	23.5	60	63	10
M 8	22	23.5	60	64	10
M 9	22	23.5	60	70	10
M10	22	23.5	60	74	10
M12	23	23.5	60	96	10
M13	24	23.5	60	116	10
M14	24	23.5	60	122	10
M16	24	25	60	135	10

4027-100	D (mm)	H (mm)	L (mm)	(g)	(pcs.)
M 5	22	63.5	100	67	10
M 6	22	63.5	100	68	10
M 7	22	63.5	100	75	10
M 8	22	63.5	100	81	10
M 9	22	63.5	100	90	10
M10	22	63.5	100	101	10
M12	23	63.5	100	134	10
M13	24	63.5	100	155	5
M14	24	63.5	100	173	5
M16	24	60	100	241	5

## RS4027/7-L60

 Socket Set on Rail  
Steckschlüsselsatz auf Schiene  
Jeu de douilles sur rail



4027-140	D (mm)	H (mm)	L (mm)	(g)	(pcs.)
M 8	22	103.5	140	98	10
M10	22	103.5	140	127	10
M12	23	103.5	140	171	5
M14	24	103.5	140	226	5
M16	24	100	140	320	5

RS4027/7-L60	7 Pieces set/Rail 200mm	(g)
M5, M6, M8, M10, M12, M14, M16		600

### Ribe CV

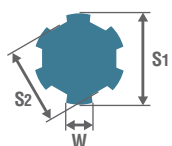

CV	M5	M6	M7	M8	M9	M10	M12	M13	M14	M16
W (ref. mm)	1.2	1.3	1.4	1.8	2.0	2.3	2.6	3.1	3.2	3.6
S <sub>1</sub> (ref. mm)	5.0	6.0	7.0	8.0	9.0	10.0	12.0	13.0	14.0	16.0
S <sub>2</sub> (ref. mm)	3.8	4.5	5.0	6.0	7.1	7.4	9.0	11.0	10.4	11.9

4110M (mm)	D (mm)	H (mm)	L (mm)	(g)	(pcs.)
8	24	10	32	57	10
10	24	10	32	62	10
10.5	24	10	32	64	10
12	24	10	32	64	10
13	24	10	32	66	10
13.5	24	10	32	67	10
14	24.2	10	32	68	10
19	25	15	37	101	10
20	26	15	37	114	10

4110A (inch)	D (mm)	H (mm)	L (mm)	(g)	(pcs.)
3/8	24	10	32	62	10
1/2	24	10	32	64	10

4101	TxW (mm)	D (mm)	L (mm)	(g)	(pcs.)
1	2.7x18.6	22	40	59	10
2	3.7x24	24	40	79	10
3	3.7x30	30	40	128	10

4137	D <sub>1</sub> (mm)	D <sub>2</sub> (mm)	L (mm)	(g)	(pcs.)
4137	13	22	38	53	10

For DIN3126 C6.3 Bits  
Für DIN3126 C6.3 Bits  
Pour DIN3126 C6.3 Embouts

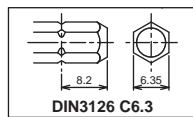

4138	D <sub>1</sub> (mm)	D <sub>2</sub> (mm)	L (mm)	(g)	(pcs.)
4138	16	22	38	62	10

For DIN3126 C8 Bits  
Für DIN3126 C8 Bits  
Pour DIN3126 C8 Embouts

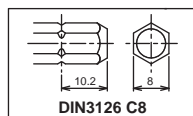

## 4110M / 4110A

4-point Male Sockets  
Öldienst-Steckschlüssel, Vierkant  
Douilles mâles 4-pans

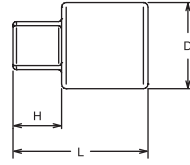

## 4101

Sockets for Slotted Heads  
Steckschlüssel für Schlitzschrauben  
Douilles tournevis pour vis à fente

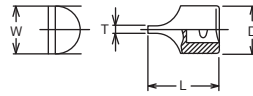

## 4137

Bit Holder  
Klingenhalter  
Porte-embouts

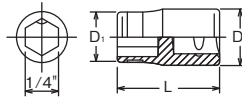

## 4138

Bit Holder  
Klingenhalter  
Porte-embouts

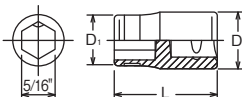

# Hand Sockets Hand Steckschlüssel Douilles à main

## 1/2"

Z-SERIES  
HAND  
TITANIUM  
SCREWDRIVERS  
ACCESSORIES  
IMPACT  
SLEEVE-DRIVE  
PROTECTOR  
INDUSTRIAL  
AUTOMOTIVE  
MOTORCYCLE  
CONSTRUCTION  
SPARE PART

**3749S-1/2** Reversible Ratchet Short  
Knarre, verstellbar  
Cliquet, réversible



\* Renewal Kits → 3749SRK-1/2 → P318

**3749SB-1/2** Reversible Ratchet short with quick release button  
Knarre, verstellbar mit Entriegelungsknopf  
Cliquet, réversible avec bouton de débrayage

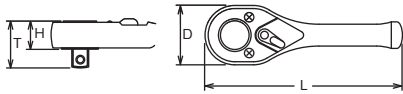

\* Renewal Kits → 3749SBRK-1/2 → P318

	D (mm)	T (mm)	H (mm)	L (mm)	(g)	(pcs.)
3749S-1/2	34	29	14.4	110	200	5
3749SB-1/2	34	29	14.4	110	200	5

**⚠** Reversible Ratchet with quick release button has less strength compared with normal ratchet due to the technical design. Make sure to use the ratchet correctly.

Die Umschaltknarre mit Entriegelungsknopf hat aufgrund der technischen Konstruktion eine geringere Festigkeit als eine normale Ratsche. Stellen Sie sicher, dass Sie die Ratsche richtig verwenden.

Le cliquet réversible avec bouton de libération rapide a une résistance moindre que le cliquet normal en raison de sa conception technique. Veillez à utiliser le cliquet correctement.

**4752J** Reversible Ratchet  
Knarre, verstellbar  
Cliquet, réversible



\* Renewal Kits → 4752RK → P319

### [L/R Marking]



A pointer and L/R markings on the ratchet head indicate the turning direction. The reduced diameter of the head allows easier access in tight spots.

Eine L/R Markierung auf dem Knarrenkopf zeigt die gerade eingestellte Drehrichtung an. Der geringe Kopfdurchmesser erleichtert das Arbeiten auch an schwer zugänglichen Stellen.

Un marquage L/R sur la tête de cliquet indique le sens de rotation.

Le diamètre de tête réduit et facilite le travail dans les endroits difficilement accessibles.

**4752N** Reversible Ratchet  
Knarre, verstellbar  
Cliquet, réversible

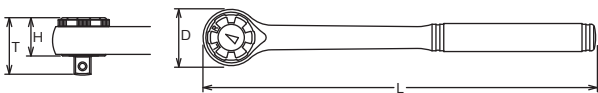

	D (mm)	T (mm)	H (mm)	L (mm)	(g)	(pcs.)
4752J	35	38.8	24.5	250	470	1
4752N	35	38.8	24.5	250	480	1

## GEAR TEETH



4749series



4753series



4750series



4752series



4774series





\* Renewal Kits → 4750RK → P318

**4750J** Reversible Ratchet  
Knarre, verstellbar  
Cliquet, réversible



\* Renewal Kits → 4750RK → P318

**4750P** Reversible Ratchet  
Knarre, verstellbar  
Cliquet, réversible



\* Renewal Kits → 4750RK → P318

**4750N** Reversible Ratchet  
Knarre, verstellbar  
Cliquet, réversible



	D (mm)	T (mm)	H (mm)	L (mm)	(g)	(pce.)
4750J	38	35.9	21.3	250	508	1
4750P	38	35.9	21.3	250	553	1
4750N	38	35.9	21.3	250	548	1

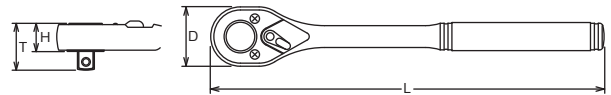

\* Renewal Kits → 4750BRK → P318

**4750JB** Reversible Ratchet with quick release button  
Knarre, verstellbar mit Entriegelungsknopf  
**4750PB** Cliquet, réversible avec bouton de débrayage ⚠  
**4750NB**



	D (mm)	T (mm)	H (mm)	L (mm)	(g)	(pce.)
4750JB	38	35.9	21.3	250	508	1
4750PB	38	35.9	21.3	250	553	1
4750NB	38	35.9	21.3	250	548	1

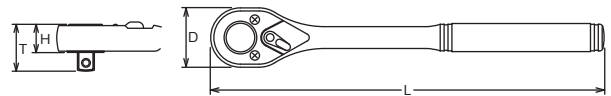

⚠ Reversible Ratchet with quick release button has less strength compared with normal ratchet due to the technical design. Make sure to use the ratchet correctly.

Die Umschaltknarre mit Entriegelungsknopf hat aufgrund der technischen Konstruktion eine geringere Festigkeit als eine normale Ratsche. Stellen Sie sicher, dass Sie die Ratsche richtig verwenden.

Le cliquet réversible avec bouton de libération rapide a une résistance moindre que le cliquet normal en raison de sa conception technique. Veuillez à utiliser le cliquet correctement.

## [4750 series]

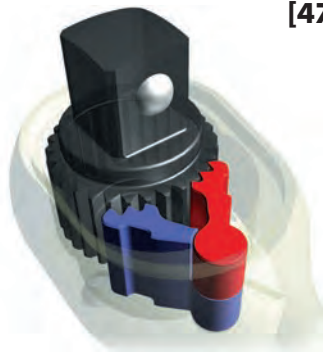

Two dogs are set in the same axis and the three teeth hold the ratchet gear. The enlarged contact area produces an about 10% higher torque value and the S.O.D.H system provides smooth and light movements.

Die scharnierartig eingelagerten Sperrklinken haben jetzt jeweils drei Zähne im Eingriff. Die dadurch vergrößerte Greiffläche erhöht das maximale Drehmoment um ca. 10%. Auch diese Knarre besticht durch ihren leichten und geschmeidigen Lauf.

Les deux rochets étant placés sur le même axe, les trois dents de l'engrenage sont engagées en permanence. Ce système assure une augmentation de 10% du couple maximum admissible. Ce cliquet se caractérise également par son fonctionnement souple et sans à-coup.

# Hand Sockets Hand Steckschlüssel Douilles à main

## 1/2"

Z-SERIES  
HAND  
TITANIUM  
SCREWDRIVERS ACCESSORIES  
IMPACT  
SLEEVE-DRIVE  
PROTECTOR  
INDUSTRIAL  
AUTOMOTIVE  
MOTORCYCLE  
CONSTRUCTION  
SPARE PART

**4753J** Reversible Ratchet  
Knarre, verstellbar  
Cliquet, réversible



\* Renewal Kits → 4753RK → P318

**4753P** Reversible Ratchet  
Knarre, verstellbar  
Cliquet, réversible



\* Renewal Kits → 4753RK → P318

**4753N** Reversible Ratchet  
Knarre, verstellbar  
Cliquet, réversible



\* Renewal Kits → 4753RK → P318

**D4753J** Reversible Ratchet  
Knarre, verstellbar  
Cliquet, réversible



\* Renewal Kits → 4753RK → P318

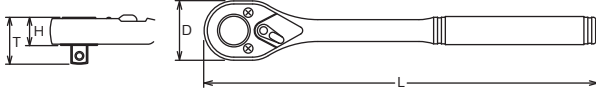

Special ratchet, surface phosphatised, no chrome flaking possible  
Sonderknarre Oberfläche phosphatiert, keine Chromabplatzungen möglich  
Cliquet spécial surface phosphatée, pas d'écaillage du chrome possible

	D (mm)	T (mm)	H (mm)	L (mm)	(g)	(pce.)
4753J	38	36.2	21.6	250	545	1
4753P	38	36.2	21.6	250	570	1
4753N	38	36.2	21.6	250	595	1
D4753J	38	36.2	21.6	250	510	1

**4753JB** Reversible Ratchet with quick release button  
Knarre, verstellbar mit Entriegelungsknopf

**4753PB**

**4753NB**

Cliquet, réversible avec bouton de débrayage



\* Renewal Kits → 4753BRK → P318

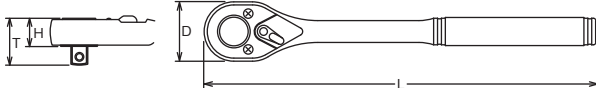

**Reversible Ratchet with Quick Release Button :**

Sockets and accessories are safely locked. By pushing the button the sockets or extension bars are released from the ratchet.

**Umstellbare Knarre mit Entriegelungsknopf :**

Steckschlüssel und Zubehörteile werden sicher und fest gehalten. Bei Drücken des Knopfes lösen sich die Teile.

**Cliquet réversible avec bouton de débrayage :**

Les douilles et accessoires ne peuvent plus tomber. Une pression du pouce sur le bouton suffit pour les libérer.



**!** Reversible Ratchet with quick release button has less strength compared with normal ratchet due to the technical design. Make sure to use the ratchet correctly.

Die Umschaltknarre mit Entriegelungsknopf hat aufgrund der technischen Konstruktion eine geringere Festigkeit als eine normale Ratsche. Stellen Sie sicher, dass Sie die Ratsche richtig verwenden.

Le cliquet réversible avec bouton de libération rapide a une résistance moindre que le cliquet normal en raison de sa conception technique. Veillez à utiliser le cliquet correctement.

	D (mm)	T (mm)	H (mm)	L (mm)	(g)	(pce.)
4753JB	38	36.2	21.6	250	545	1
4753PB	38	36.2	21.6	250	570	1
4753NB	38	36.2	21.6	250	595	1



**4749J-380**  
**4749N-380**

Reversible Ratchet (long)  
Verstellbare Knarre, lang  
Cliquet réversible, long

\* Renewal Kits → 4749RK → P318



	D (mm)	T (mm)	H (mm)	L (mm)	(g)	(pce.)
4749J-380	44.6	33	18.4	380	743	1
4749N-380	44.6	33	18.4	380	753	1

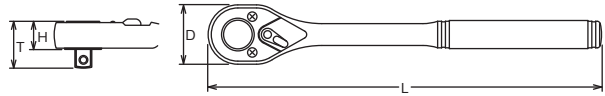

**4753P-410**

Reversible Ratchet (long)  
Verstellbare Knarre, lang  
Cliquet réversible, long



\* Renewal Kits → 4753RK → P318



	D (mm)	T (mm)	H (mm)	L (mm)	(g)	(pce.)
4753P-410	38	36.2	21.6	410	790	1

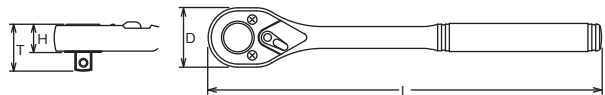

**⚠** 4753P-410 have longer handle than standard, and can be loaded to excessive torque value. In the interest of your own safety always apply load evenly and progressively to avoid breakage and possible injury.

Sie haben einen längeren Griff als Standardprodukte und können mit einem übermäßigen Drehmoment belastet werden. Im Interesse Ihrer eigenen Sicherheit sollten Sie sie immer gleichmäßig und schrittweise belasten, um Brüche und mögliche Verletzungen zu vermeiden.



**4774J**  
**4774P**  
**4774N**

Flexible Ratchet, reversible  
Gelenk-Knarre, verstellbar  
Cliquet articulé, réversible

\* Renewal Kits → 4753RK → P318

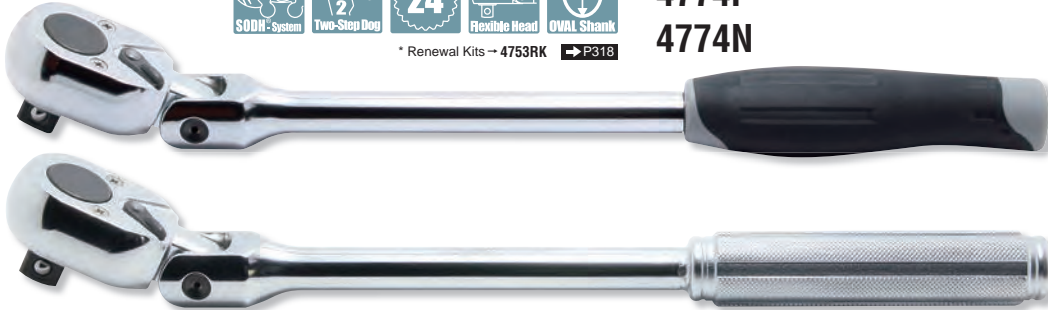

	D (mm)	T (mm)	H (mm)	L (mm)	(g)	(pce.)
4774J	38	36.2	21.6	330	685	1
4774P	38	36.2	21.6	330	700	1
4774N	38	36.2	21.6	330	700	1

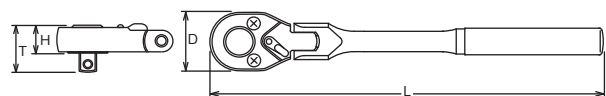

**4774P-450**

Flexible Ratchet (long), reversible  
Gelenk-Knarre lang, verstellbar  
Cliquet articulé long, réversible



\* Renewal Kits → 4753RK → P318



	D (mm)	T (mm)	H (mm)	L (mm)	(g)	(pce.)
4774P-450	38	36.2	21.6	450	790	1

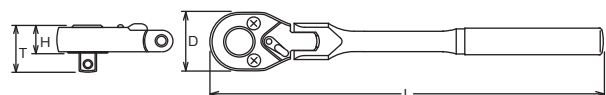

**⚠** 4774P-450 has longer handle than standard, and can be loaded to excessive torque value. In the interest of your own safety always apply load evenly and progressively to avoid breakage and possible injury.

Sie haben einen längeren Griff als Standardprodukte und können mit einem übermäßigen Drehmoment belastet werden. Im Interesse Ihrer eigenen Sicherheit sollten Sie sie immer gleichmäßig und schrittweise belasten, um Brüche und mögliche Verletzungen zu vermeiden.

# Hand Sockets Hand Steckschlüssel Douilles à main

## 1/2"

Z-SERIES

HAND

TITANIUM

SCREWDRIVERS ACCESSORIES

IMPACT

SLEEVE-DRIVE

PROTECTOR

INDUSTRIAL

AUTOMOTIVE

MOTORCYCLE

CONSTRUCTION

SPARE PART

**4774JB** Flexible Ratchet, reversible with quick release button  
**4774PB** Gelenk-Knarre, verstellbar mit Entriegelungsknopf  
**4774NB** Cliquet, articulé, réversible avec bouton de débrayage



\* Renewal Kits → **4753BRK** → P318



OVAL SHAPE SHANK

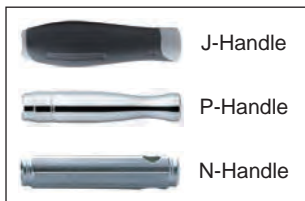
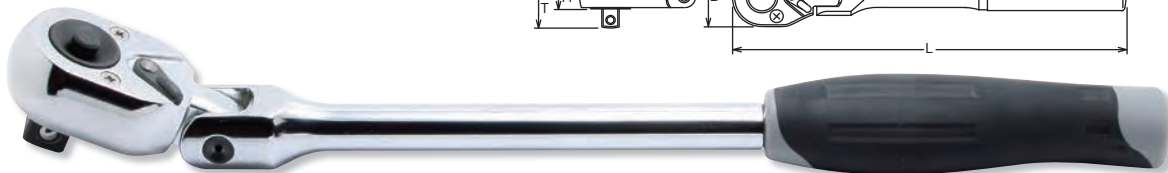
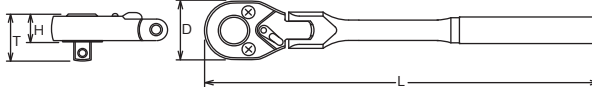

GRIP VARIATION

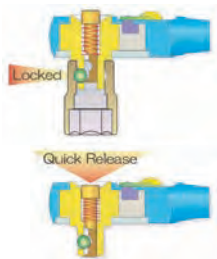

	D (mm)	T (mm)	H (mm)	L (mm)	(g)	(pcs.)
<b>4774JB</b>	38	36.2	21.6	330	685	1
<b>4774PB</b>	38	36.2	21.6	330	700	1
<b>4774NB</b>	38	36.2	21.6	330	700	1

#### Reversible Ratchet with Quick Release Button :

Sockets and accessories are safely locked. By pushing the button the sockets or extension bars are released from the ratchet.

#### Umstellbare Knarre mit Entriegelungsknopf :

Steckschlüssel und Zubehörteile werden sicher und fest gehalten. Bei Drücken des Knopfes lösen sich die Teile.

#### Cliquet réversible avec bouton de débrayage :

Les douilles et accessoires sont bien fixés. En poussant le bouton ils se libèrent facilement.

**⚠** Reversible Ratchet with quick release button has less strength compared with normal ratchet due to the technical design. Make sure to use the ratchet correctly.

Die Umschaltknarre mit Entriegelungsknopf hat aufgrund der technischen Konstruktion eine geringere Festigkeit als eine normale Ratsche. Stellen Sie sicher, dass Sie die Ratsche richtig verwenden.

Le cliquet réversible avec bouton de libération rapide a une résistance moindre que le cliquet normal en raison de sa conception technique. Veillez à utiliser le cliquet correctement.

**4755** Ratchet Adaptor  
Aufsteckknarre  
Cliquet adaptable

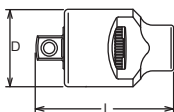

**45**

\* Renewal Kits → **4755RK** → P319

	D (mm)	L (mm)	(g)	(pcs.)
<b>4755</b>	33.5	65	270	5

**4756** Quick Spinner  
Rändel-Drehscheibe  
Lanceur

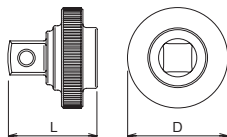

	D (mm)	L (mm)	(g)	(pcs.)
<b>4756</b>	38	34.5	95	10

**4768J-380 / -450 / -600** Hinge Handles  
Gelenkgriffe  
Poignées articulées



**4768P-380 / -450 / -600**

Hinge Handles  
Gelenkgriffe  
Poignées articulées

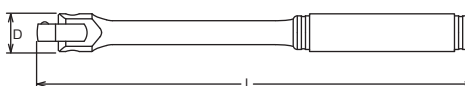

\* Renewal Kits → **4768RK** → P321



**⚠** 4768-450/600 have longer handle than standard, and can be loaded to excessive torque value. Please use carefully.

Der 4768-450 und 4768-600 hat einen längeren Griff als die Standardausführung und kann mit einem zu hohen Drehmoment belastet werden. Bitte vorsichtig verwenden.

Les modèles 4768-450 et 4768-600 ont une poignée plus longue que la norme et peuvent être soumis à un couple excessif. Pour votre sécurité, appliquez toujours la charge de manière uniforme et progressive afin d'éviter toute rupture et blessure.

	D (mm)	L (mm)	(g)	(pcs.)
<b>4768J-380</b>	28	380	600	1
<b>4768J-450</b>	28	450	690	1
<b>4768J-600</b>	28	600	1120	1
<b>4768P-380</b>	28	380	665	2
<b>4768P-450</b>	28	450	748	2
<b>4768P-600</b>	28	600	1170	1

	D (mm)	d (mm)	L (mm)	(g)	(pcs.)
4760-35	24	-	35	56	10
4760-50	24	16	50	92	10
4760-75	24	14.3	75	138	10
4760-100	24	14.3	100	158	5
4760-125	24	14.3	125	194	5
4760-150	24	14.3	150	266	5
4760-200	24	14.3	200	295	5
4760-250	24	14.3	250	358	5
4760-300	24	16	300	492	2
4760-400	24	16	400	650	1
4760-500	24	16	500	808	1
4760-600	24	16	600	968	1
4760-900	24	16	900	1430	1
4760-1000	24	16	1000	1593	1

**PK4760/5** 5 Pieces Set/△=1,050g  
PLASTIC TRAY  
Extension Bars  
4760 Extension Bars  
50, 75, 125, 150, 250

Rotation and general handling of extensions with oily hands is greatly improved with the **Kokon** developed 6 point knurling. Also the **Kokon** 6 point knurling stops the extensions from rolling around the work area.

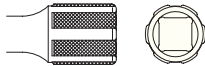

Durch die von **Kokon** entwickelte 6 fache Rändelung wird die Handhabung deutlich erleichtert. Außerdem wird das Herumrollen der Verlängerungen wirksam verhindert.

La manipulation des rallonges est grandement facilitée par le profil moleté développé par **Kokon**. Ce même profil empêche le roulement intempêtif des rallonges sur le plan de travail.

## 4760 Extension Bars Verlängerungen Rallonges

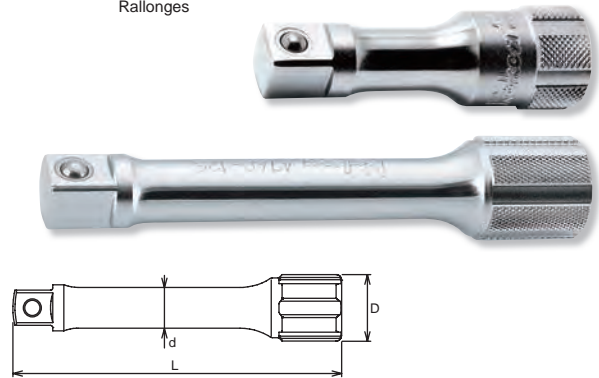

## PK4760/5 Extension Bars in Plastic Box Verlängerungen in Kunststoff-Kassette Rallonges en boîte plastique



	D (mm)	d (mm)	L (mm)	(g)	(pcs.)
4763-50	24	16.5	50	95	10
4763-75	24	12	75	111	10
4763-125	24	12	125	157	5
4763-150	24	12	150	181	5
4763-250	24	12	250	357	5
4763-300	24	12	300	480	2
4763-400	24	12	400	650	1



## 4763 Wobble-Fix Extension Bars Winkel-Verlängerungen Rallonges angulaires



**⚠** The Wobble-Fix Extension Bar has less strength than normal extension bar due to it's specific design with a reduced square drive. Make sure to use it correctly.

Die Wobble-Fix Verlängerungen haben aufgrund ihrer speziellen Konstruktion mit einem reduzierten Vierkanttrieb eine geringere Festigkeit als eine normale Verlängerung. Achten Sie darauf, sie richtig zu verwenden.

La barre d'extension angulaire est moins résistante qu'une barre d'extension normale en raison de sa conception spécifique avec un carré d'entraînement réduit. Veuillez l'utiliser correctement.

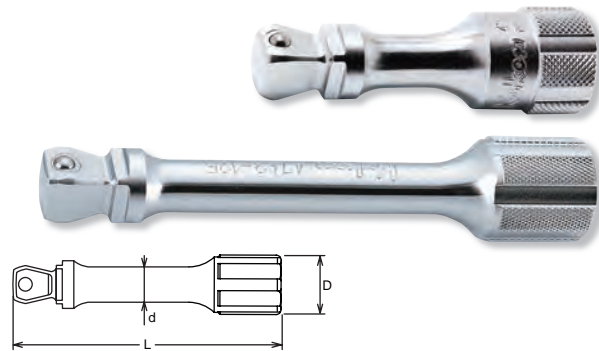

**PK4763/5** 5 Pieces Set/△=950g  
PLASTIC TRAY  
Extension Bars  
4763 Wobble-Fix Extension Bars  
50, 75, 125, 150, 250

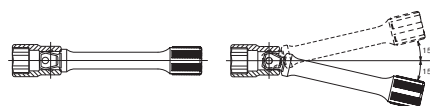

- Wobble-Fix Extension Bar**  
Two way usage  
a) In a fixed position, as a normal extension bar  
b) In a half-fixed position, as a flexible extension bar providing a 15° angle operation

- Winkel-Verlängerungen**  
Winkelverlängerungen lassen sich in zwei Einstellungen verwenden  
a) voll eingesteckt und starr,  
b) halb eingesteckt, mit einem Arbeitswinkel von 15°.

- Rallonges angulaires**  
Deux utilisations possibles  
a) comme rallonge normale, dans une position fixe  
b) comme une rallonge angulaire avec une possibilité d'inclinaison jusqu'à 15°

## PK4763/5 Wobble-Fix Extension Bars in Plastic Box Winkel Verlängerungen in Kunststoff-Kassette Rallonges angulaires en boîte plastique



Hand Sockets  
Hand Steckschlüssel  
Douilles à main

# 1/2"

Z-SERIES  
HAND  
TITANIUM  
SCREWDRIVERS ACCESSORIES  
IMPACT  
SLEEVE-DRIVE  
PROTECTOR  
INDUSTRIAL  
AUTOMOTIVE  
MOTORCYCLE  
CONSTRUCTION  
SPARE PART

**4770** Universal Joint  
Gelenk-Einsatz  
Cardan universel

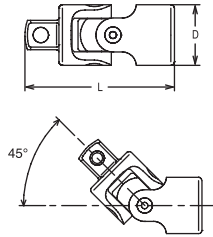

	D (mm)	L (mm)	(g)	(pcs.)
<b>4770</b>	25	62.4	150	10

**4771** Universal Joint  
Gelenk-Einsatz  
Joint articulé

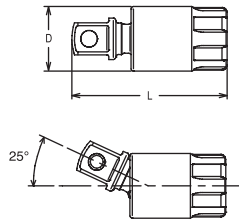

	D (mm)	L (mm)	(g)	(pcs.)
<b>4771</b>	23.7	57.7	113	10

**4780-400** Speed Handle  
Winde  
Vilebrequin

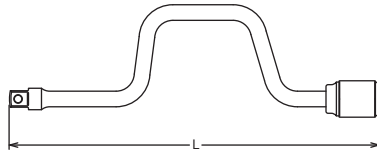

	L (mm)	(g)	(pce.)
<b>4780</b>	400	644	1

**4781N-450** Flexible Speed Handle  
Gelenkgriff-Winde  
Vilebrequin

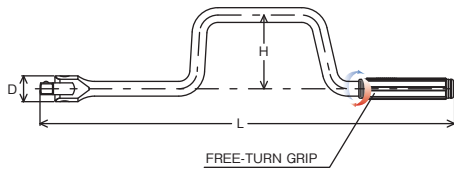

\* Renewal Kits → **4768RK** → **P321**

	D (mm)	H (mm)	L (mm)	(g)	(pce.)
<b>4781N-450</b>	28	80	450	1000	1

**4785** T-Handle  
T-Griff  
Poignée coulissante



	H (mm)	L (mm)	(g)	(pcs.)
<b>4785</b>	42	300	410	2

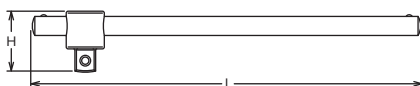



**4747** L-Handle  
L-Griff  
Poignées en L



	L <sub>1</sub> (mm)	L <sub>2</sub> (mm)	(g)	(pcs.)
<b>4747</b>	263	53	470	1

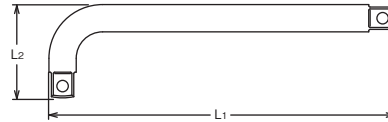

**4788-250 / -300 / -450** ⚠ L-Handles  
L-Griffe  
Poignées en L

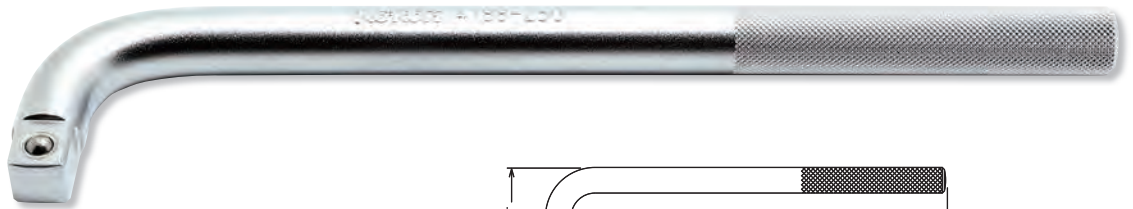

	L <sub>1</sub> (mm)	L <sub>2</sub> (mm)	(g)	(pcs.)
<b>4788-250</b>	250	53	417	2
<b>4788-300</b>	300	53	503	1
<b>4788-450</b>	450	53	745	1



⚠ 4788-450 have longer handle than standard, and can be loaded to excessive torque value. In the interest of your own safety always apply load evenly and progressively to avoid breakage and possible injury.

	(sq.)	(sq.)	D (mm)	L (mm)	(g)	(pcs.)
<b>4433A-35</b>	1/2"	3/8"	21.9	35	50	10
<b>4433A-75</b>	1/2"	3/8"	21.9	75	120	10
<b>4433A-125</b>	1/2"	3/8"	21.9	125	164	5
<b>4433A-250</b>	1/2"	3/8"	21.9	250	275	5
<b>4433A-600</b>	1/2"	3/8"	21.9	600	530	1

Items in this catalogue marked ⚠ can be loaded to torque values which may cause breakage.

In the interest of your own safety always apply load evenly and progressively to avoid breakage and possible injury.

Die mit ⚠ gekennzeichneten Artikel können bei Überbelastungen zu Bruch gehen. Aus Gründen Ihrer Sicherheit, sollten die betreffenden Werkzeuge nie ruckartig, sondern nach und nach belastet werden, um Bruch und damit verbundene, mögliche Verletzungen zu vermeiden.

Il est possible d'appliquer aux articles marqués ⚠ des couples de serrage susceptibles d'occasionner leur rupture. Pour votre propre sécurité, veuillez toujours appliquer la charge d'une manière uniforme et progressive. Ceci pour éviter ruptures et accidents.

	(sq.)	(sq.)	D (mm)	L (mm)	(g)	(pcs.)
<b>4466A</b>	1/2"	3/4"	25	42	108	10

**4433A** Adaptors  
Verbindungsstücke  
Réducteurs

Warranty 290Nm  
Garantie 290Nm  
Garantie 290Nm ⚠

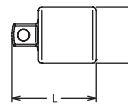

**4466A** Adaptor  
Verbindungsstück  
Réducteurs

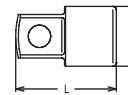

Hand Sockets  
Hand Steckschlüssel  
Douilles à main **1/2"**



Z-SERIES  
HAND  
TITANIUM  
SCREWDRIVERS ACCESSORIES  
IMPACT  
SLEEVE-DRIVE  
PROTECTOR  
INDUSTRIAL  
AUTOMOTIVE  
MOTORCYCLE  
CONSTRUCTION  
SPARE PART

**4223M-01** Socket Sets  
Steckschlüssel Sätze  
**4223M-06** Jeu de clés à douille



4223M-01 15 Pieces Set/⚖️=2,600g  
4223M-06 15 Pieces Set/⚖️=2,600g

METAL CASE:W415xH120xT50mm







Sockets	Accessories
(4223M-01) <b>4401M</b> 6-pt. Sockets 10, 11, 12, 13, 14, 15, 16, 17, 18, 19, 21, 22	 <b>4753J</b>
(4223M-06) <b>4406M</b> 12-pt. Sockets 10, 11, 12, 13, 14, 15, 16, 17, 18, 19, 21, 22	 <b>4760-125</b>  <b>4770</b>

**4238AM** Socket Sets  
Steckschlüssel Sätze  
Jeu de clés à douille





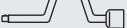

**4238AM** 38 Pieces Set/⚖️=8,050g

METAL CASE:W446xH266xT50mm

Sockets	Accessories
<b>4405M</b> 12-pt. Sockets 10, 11, 12, 13, 14, 15, 16, 17, 18, 19, 21, 22, 23, 24, 26, 27, 30, 32	 <b>4753N</b>  <b>4760-125</b>
<b>4405A</b> 12-pt. Sockets 3/8, 7/16, 1/2, 9/16, 5/8, 11/16, 3/4, 13/16, 7/8, 15/16, 1.1/16, 1.1/8, 1.1/4	 <b>4760-250</b>  <b>4770</b>
<b>4300C</b> Spark Plug Socket 20.8	 <b>4780</b>  <b>4785</b>

4241M-01	28 Pieces Set/△=6,500g
4241M-06	28 Pieces Set/△=6,500g
4241M-10	28 Pieces Set/△=6,500g

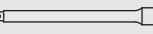
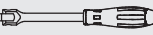
METAL CASE:W446xH266xT50mm

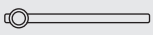
Sockets	Accessories
(4241M-01) <b>4401M</b> 6-pt. Sockets 10, 11, 12, 13, 14, 15, 16, 17, 18, 19, 20, 21, 22, 23, 24, 25, 26, 27, 28, 29, 30, 32	 <b>4753J</b>  <b>4760-125</b>  <b>4760-250</b>  <b>4768J-380</b>
(4241M-06) <b>4406M</b> 12-pt. Sockets 10, 11, 12, 13, 14, 15, 16, 17, 18, 19, 20, 21, 22, 23, 24, 25, 26, 27, 28, 29, 30, 32	 <b>4770</b>  <b>4785</b>
(4241M-10) <b>4410M</b> Surface Drive Sockets 10, 11, 12, 13, 14, 15, 16, 17, 18, 19, 20, 21, 22, 23, 24, 25, 26, 27, 28, 29, 30, 32	

## 4241M-01

Socket Sets  
Steckschlüssel Sätze  
Jeu de clés à douille







## 4241M-06

## 4241M-10

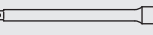

4241A-00	19 Pieces Set/△=4,900g
4241A-05	19 Pieces Set/△=4,900g

METAL CASE:W445xH190xT50mm

Sockets	Accessories
(4241A-00) <b>4400A</b> 6-pt. Sockets 3/8, 7/16, 1/2, 9/16, 5/8, 11/16, 3/4, 13/16, 7/8, 15/16, 1.1/16, 1.1/8, 1.1/4	 <b>4753J</b>  <b>4760-125</b>  <b>4760-250</b>  <b>4768J-380</b>
(4241A-05) <b>4405A</b> 12-pt. Sockets 3/8, 7/16, 1/2, 9/16, 5/8, 11/16, 3/4, 13/16, 7/8, 15/16, 1.1/16, 1.1/8, 1.1/4	 <b>4770</b>  <b>4785</b>

## 4241A-00





Socket Sets  
Steckschlüssel Sätze  
Jeu de clés à douille

## 4241A-05

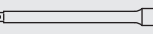

4249M-01	20 Pieces Set/△=4,800g
4249M-06	20 Pieces Set/△=4,800g

METAL CASE:W445xH190xT50mm

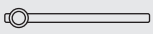
Sockets	Accessories
(4249M-01) <b>4401M</b> 6-pt. Sockets 10, 11, 12, 13, 14, 15, 16, 17, 18, 19, 21, 22, 24, 27, 30	 <b>4753J</b>  <b>4760-125</b>  <b>4760-250</b>  <b>4770</b>
(4249M-06) <b>4406M</b> 12-pt. Sockets 10, 11, 12, 13, 14, 15, 16, 17, 18, 19, 21, 22, 24, 27, 30	 <b>4785</b>

## 4249M-01





Socket Sets  
Steckschlüssel Sätze  
Jeu de clés à douille

## 4249M-06

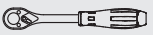

4250M-01	18 Pieces Set/△=4,700g
4250M-06	18 Pieces Set/△=4,700g
4250M-10	18 Pieces Set/△=4,700g

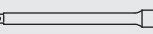
METAL CASE:W445xH190xT50mm

Sockets	Accessories
(4250M-01) <b>4401M</b> 6-pt. Sockets 10, 11, 12, 13, 14, 15, 17, 19, 22, 24, 27, 30, 32	 <b>4753J</b>  <b>4760-125</b>  <b>4760-250</b>
(4250M-06) <b>4406M</b> 12-pt. Sockets 10, 11, 12, 13, 14, 15, 17, 19, 22, 24, 27, 30, 32	 <b>4770</b>  <b>4785</b>
(4250M-10) <b>4410M</b> Surface Drive Sockets 10, 11, 12, 13, 14, 15, 17, 19, 22, 24, 27, 30, 32	

## 4250M-01

Socket Sets  
Steckschlüssel Sätze  
Jeu de clés à douille

## 4250M-06

## 4250M-10



Hand Sockets  
Hand Steckschlüssel  
Douilles à main

# 1/2"

Z-SERIES  
HAND  
TITANIUM  
SCREWDRIVERS ACCESSORIES  
IMPACT  
SLEEVE-DRIVE  
PROTECTOR  
INDUSTRIAL  
AUTOMOTIVE  
MOTORCYCLE  
CONSTRUCTION  
SPARE PART

- 4251M-01** Socket Sets  
Steckschlüssel Sätze  
Jeu de clés à douille
- 4251M-06**
- 4251M-10**
- 4251A-00**
- 4251A-05**



4251M-01	22 Pieces Set/⚖️=3,200g
4251M-06	22 Pieces Set/⚖️=3,200g
4251M-10	22 Pieces Set/⚖️=3,200g
4251A-00	18 Pieces Set/⚖️=2,700g
4251A-05	18 Pieces Set/⚖️=2,700g

METAL CASE:W337xH76xT52mm

Sockets	
(4251M-01) <b>4401M</b> 6-pt. Sockets	10, 11, 12, 13, 14, 15, 16, 17, 18, 19, 20, 21, 22, 23, 24, 25, 26, 27, 28, 29, 30, 32
(4251M-06) <b>4406M</b> 12-pt. Sockets	
(4251M-10) <b>4410M</b> Surface Drive Sockets	
(4251A-00) <b>4400A</b> 6-pt. Sockets	3/8, 7/16, 1/2, 9/16, 19/32, 5/8, 21/32, 11/16, 3/4, 25/32, 13/16, 7/8, 15/16, 1, 1.1/16, 1.1/8, 1.3/16, 1.1/4
(4251A-05) <b>4405A</b> 12-pt. Sockets	

- 4252M-01** Socket Sets  
Steckschlüssel Sätze  
Jeu de clés à douille
- 4252M-06**
- 4252M-10**



4252M-01	13 Pieces Set/⚖️=1,200g
4252M-06	13 Pieces Set/⚖️=1,200g
4252M-10	13 Pieces Set/⚖️=1,200g

METAL CASE:W168xH60xT42mm

Sockets	
(4252M-01) <b>4401M</b> 6-pt. Sockets	10, 11, 12, 13, 14, 15, 16, 17, 18, 19, 20, 21, 22
(4252M-06) <b>4406M</b> 12-pt. Sockets	
(4252M-10) <b>4410M</b> Surface Drive Sockets	

- 4254** Socket Sets  
Steckschlüssel Sätze  
Jeu de clés à douille



4254	12 Pieces Set/⚖️=1,070g
------	-------------------------

METAL CASE:W215xH80xT47mm

Sockets		Accessories	
3/8"	3425- E6, E8		4763-50
1/2"	4425- E10, E12, E14		4433A-35
3/8"	3325- E6, E8		
1/2"	4325- E10, E12, E14		

- 4262M-01** Socket Sets  
Steckschlüssel Sätze  
Jeu de clés à douille
- 4262M-06**
- 4262M-10**







4262M-01	20 Pieces Set/⚖️=4,400g
4262M-06	20 Pieces Set/⚖️=4,400g
4262M-10	20 Pieces Set/⚖️=4,400g

METAL CASE:W445xH190xT50mm

Sockets		Accessories	
(4262M-01) <b>4401M</b> 6-pt. Sockets	8, 10, 11, 12, 13, 14, 15, 16, 17, 18, 19, 21, 22, 24, 27		4753J
(4262M-06) <b>4406M</b> 12-pt. Sockets	8, 10, 11, 12, 13, 14, 15, 16, 17, 18, 19, 21, 22, 24, 27		4760-125
(4262M-10) <b>4410M</b> Surface Drive Sockets	8, 10, 11, 12, 13, 14, 15, 16, 17, 18, 19, 21, 22, 24, 27		4770
			4785

4272AM-01 29 Pieces Set/△=5,000g  
4272AM-06 29 Pieces Set/△=5,000g

METAL CASE:W445xH190xT50mm

Sockets	Accessories
(4272AM-01) <b>4401M</b> 6-pt. Sockets 10, 11, 12, 13, 14, 15, 16, 17, 18, 19, 21, 22, 24	 <b>4753J</b>
<b>4400A</b> 6-pt. Sockets 3/8, 7/16, 1/2, 9/16, 5/8, 11/16, 3/4, 13/16, 7/8, 15/16, 1	 <b>4760-125</b>
(4272AM-06) <b>4406M</b> 12-pt. Sockets 10, 11, 12, 13, 14, 15, 16, 17, 18, 19, 21, 22, 24	 <b>4760-250</b>
<b>4405A</b> 12-pt. Sockets 3/8, 7/16, 1/2, 9/16, 5/8, 11/16, 3/4, 13/16, 7/8, 15/16, 1	 <b>4770</b>
	 <b>4785</b>





## 4272AM-01 4272AM-06

Socket Sets  
Steckschlüssel Sätze  
Jeu de clés à douille

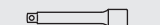
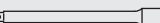

4275 24 Pieces Set/△=5,340g

METAL CASE:W445xH190xT50mm

Sockets	Accessories
<b>4406M</b> 12-pt. Sockets 10, 11, 12, 13, 14, 15, 16, 17, 18, 19, 21, 22, 24	 <b>4750J</b>
<b>4300C</b> Spark Plug Sockets 16, 20.8	 <b>4760-125</b>
<b>4300M</b> Wheel Nut Sockets 17(L60), 19(L60), 21(L60)	 <b>4760-250</b>
	 <b>4768J-380</b>
	 <b>4770</b>
	 <b>4785</b>

## 4275

Socket Sets  
Steckschlüssel Sätze  
Jeu de clés à douille



4276 17 Pieces Set/△=2,890g

METAL CASE:W370xH150xT50mm

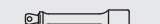
Sockets	Accessories
<b>4010M.50</b> Bit Sockets 6, 7, 8, 10, 12, 14	 <b>4752J</b>
<b>4025.60</b> TORX® Bit Sockets T20, T25, T27, T30, T40, T45, T50, T55, T60	 <b>4763-125</b>



## 4276

Socket Sets  
Steckschlüssel Sätze  
Jeu de clés à douille

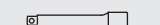

4277 27 Pieces Set/△=5,660g

METAL CASE:W445xH190xT50mm

Sockets	Accessories
<b>4406M</b> 12-pt. Sockets 10, 12, 13, 14, 15, 16, 17, 18, 19, 21, 22, 24	 <b>4750J</b>
<b>4305M</b> 12-pt. Deep Sockets 10, 12, 13, 14, 15, 16, 17, 18, 19, 21, 22, 24	 <b>4760-125</b>
	 <b>4768J-380</b>

## 4277

Socket Sets  
Steckschlüssel Sätze  
Jeu de clés à douille



## 6400M / 6400A

6-point Sockets  
6-kant Steckschlüssel  
Douilles 6-pans

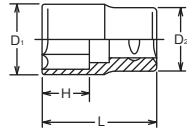

6400M 6405M (mm)	D <sub>1</sub> (mm)	D <sub>2</sub> (mm)	H (mm)	L (mm)	(g)	(pcs.)
14	22.1	34	11	50	160	10
16	24.6	34	12	50	167	10
17	26	34	12.5	50	175	5
18	27	34	13	50	178	5
19	28.5	34	13.5	50	179	5
20	29.5	34	14	50	185	5
21	31	34	14.5	50	185	5
22	32	34	15	50	187	5
23	33.5	34	16	50	187	5
24	34.5	34	17	50	200	5
25	36	34	17.5	50	217	5
26	37	34	18	50	222	5
27	38.5	37	19	53	254	5
28	39.5	38	19.5	53	298	5
29	41	38	20	55	292	5
30	42	38	21	55	301	5
31	43.5	38	22	57	294	5
32	44.5	40	23	57	351	5
33	46	40	23.5	57	384	5
34	47	40	24	57	397	5
35	48.5	42	24.5	59	422	5
36	49.5	42	25	59	438	5
37	51	42	25.5	59	484	5
38	52	45	26	59	523	5
39	53.5	45	26.5	59	538	5
40	54.5	45	27	62	550	5
41	56	47	28	62	633	5
42	57	47	28.5	62	652	2
43	58.5	47	29	62	659	2
44	59.5	47	29.5	62	657	2
45	61	47	30	68	734	2
46	62	47	31	68	791	2
47	63.5	48	31.5	68	816	2
48	64.5	45	32	68	800	2
50	67	48	34	68	880	2
52	69.5	53	33	72	925	2
54	72	55	33	72	1040	2
55	73.5	53	36	72	1006	2
56	74.5	53	36	72	1092	2
57	76	53	36	72	1169	2
58	77	53	36	72	1149	2
60	79.5	58	39	76	1402	2
63	83.5	58	39	76	1494	2
65	86	63	42	80	1608	2
70	92	68	45	84	1785	2
75	98.5	73	48	86	2186	1
78	102.1	73	55	86	2425	1
80	104.5	78	52	90	2475	1
85	111	78	52	90	2620	1

## 6405M / 6405A

12-point Sockets  
12-kant Steckschlüssel  
Douilles 12-pans

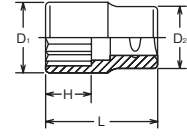

6400A 6405A (inch)	D <sub>1</sub> (mm)	D <sub>2</sub> (mm)	H (mm)	L (mm)	(g)	(pcs.)
5/8	24.6	34	12	50	168	10
11/16	27	34	13	50	178	5
3/4	28.5	34	13.5	50	179	5
25/32	29.5	34	14	50	185	5
13/16	31	34	14.5	50	185	5
7/8	32	34	15	50	187	5
15/16	34.5	34	17	50	200	5
31/32	36	34	17.5	50	217	5
1	37	34	18	50	222	5
1. 1/16	38.5	37	19	53	254	5
1. 1/8	41	38	20	53	292	5
1. 3/16	42	38	21	55	301	5
1. 1/4	44.5	40	23	57	351	5
1. 5/16	46	40	23.5	57	384	5
1. 3/8	48.5	42	24.5	57	422	5
1. 7/16	51	42	25.5	59	484	5
1. 1/2	52	45	26	59	523	5
1. 9/16	54.5	45	27	59	550	5
1. 5/8	56	47	28	62	633	5
1.11/16	58.5	47	29	62	659	2
1. 3/4	59.5	47	29.5	62	657	2
1.13/16	62	47	31	68	791	2
1. 7/8	64.5	45	32	68	892	2
1.15/16	66	48	32.5	68	870	2
2	68.5	52	34.5	68	949	2
2. 1/16	71	54	33	72	983	2
2. 1/8	72	55	33	72	1040	2
2. 3/16	74.5	53	36	72	1092	2
2. 1/4	76	53	36	72	1169	2
2. 5/16	78.5	53	36	72	1344	2
2. 3/8	79.5	58	39	76	1402	2
2. 7/16	82	58	39	76	1420	2
2. 1/2	84.5	58	39	76	1497	2
2. 9/16	86	63	42	80	1608	2
2. 5/8	88.5	63	42	80	1709	2
2.11/16	89.5	63	42	80	1634	2
2. 3/4	92	68	45	84	1785	2
2.13/16	94.5	68	45	84	2018	2
2. 7/8	96	68	45	84	2062	2
2.15/16	98.5	73	48	86	2186	1
3	101	73	48	86	2309	1
3. 1/8	104.5	78	52	90	2475	1

## 6425

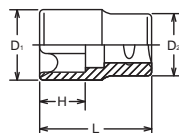

TORX® Sockets  
TORX® Steckschlüssel  
Douilles TORX®



6425 (E)	D <sub>1</sub> (mm)	D <sub>2</sub> (mm)	H (mm)	L (mm)	(g)	(pcs.)
E18	22.1	34	11.9	50	156	5
E20	24.6	34	13.3	50	166	5
E22	27.1	34	14.4	50	178	5
E24	28.6	34	16	50	185	5
E26	31.1	34	17.7	55	217	5
E28	32.1	34	24.1	60	237	5
E30	35	34	24.1	60	242	5
E32	36.1	34	24.1	60	247	5

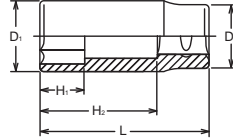

## 6300M / 6300A 6-point Deep Sockets 6-kant-Steckschlüssel,lang Douilles longues 6-pans





6300M 6305M (mm)	D <sub>1</sub> (mm)	D <sub>2</sub> (mm)	H <sub>1</sub> (mm)	H <sub>2</sub> (mm)	L (mm)	 (g)	 (pcs.)
17	26	34	18	64	90	278	5
18	27	34	19	64	90	281	5
19	28.5	34	20	64	90	292	5
20	29.5	34	21	64	90	334	5
21	31	34	22	64	90	343	5
22	32	34	23	64	90	347	5
23	33.5	34	24	64	90	361	5
24	34.5	34	25	64	90	352	5
25	36	34	26	64	90	369	5
26	37	34	27	64	90	384	5
27	38.5	37	28	64	90	425	5
28	39.5	38	29	63	90	470	5
29	41	38	30	63	90	503	5
30	42	38	31	63	90	503	5
31	43.5	38	32	62	90	517	5
32	44.5	40	34	62	90	544	5
33	46	40	34	62	90	557	5
34	47	40	35	61	90	570	5
35	48.5	42	36	61	90	622	5
36	49.5	42	37	61	90	631	2
38	52	45	39	60	90	710	2
40	54.5	45	41	60	90	742	2
41	56	47	42	59	90	802	2
42	57	47	43	59	90	829	2
44	59.5	47	45	59	90	838	2
46	62	47	47	58	90	906	2
48	64.5	50	49	57	90	998	2
50	67	48	51	57	90	1005	2
52	69.5	53	49	-	100	1270	2
53	71	54	49	-	100	1338	2
54	72	55	49	-	100	1351	2
55	73.5	53	52	-	100	1388	2
56	74.5	53	52	-	100	1389	2
57	76	53	52	-	100	1467	2
58	77	53	52	-	100	1480	2
60	79.5	58	55	-	100	1626	2
63	83.5	58	55	-	100	1740	2
65	86	63	65	-	100	1939	2

## 6305M / 6305A 12-point Deep Sockets 12-kant Steckschlüssel,lang Douilles longues, 12-pans



6300A 6305A (inch)	D <sub>1</sub> (mm)	D <sub>2</sub> (mm)	H <sub>1</sub> (mm)	H <sub>2</sub> (mm)	L (mm)	 (g)	 (pcs.)
3/4	28.5	34	20	64	90	292	5
25/32	29.5	34	21	64	90	334	5
13/16	31	34	22	64	90	343	5
7/8	32	34	23	64	90	347	5
15/16	34.5	34	25	64	90	352	5
1	37	34	27	64	90	384	5
1. 1/16	38.5	37	28	64	90	425	5
1. 1/8	41	38	30	63	90	503	5
1. 3/16	42	38	31	63	90	503	5
1. 1/4	44.5	40	34	62	90	544	5
1. 5/16	46	40	34	62	90	557	5
1. 3/8	48.5	42	36	61	90	622	5
1. 7/16	51	42	38	61	90	656	2
1. 1/2	52	45	39	60	90	710	2
1. 9/16	54.5	45	41	60	90	742	2
1. 5/8	56	47	42	59	90	802	2
1.11/16	58.5	47	44	59	90	831	2
1. 3/4	59.5	47	45	59	90	838	2
1.13/16	62	47	47	58	90	906	2
2	68.5	52	52	57	90	1061	2
2. 1/16	71	54	49	-	100	1338	2
2. 1/8	72	55	49	-	100	1351	2
2. 3/16	74.5	53	52	-	100	1389	2
2. 1/4	76	53	52	-	100	1467	2
2. 5/16	78.5	53	52	-	100	1787	2
2. 3/8	79.5	58	55	-	100	1626	2
2. 7/16	82	58	55	-	100	1715	2

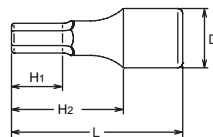

6012M-75 (mm)	D (mm)	H <sub>1</sub> (mm)	H <sub>2</sub> (mm)	L (mm)	 (g)	 (pcs.)
12	35	15.5	40	75	253	10
14	35	15.5	40	75	265	10
15	35	15.5	40	75	271	10
16	35	15.5	40	75	285	10
17	35	15.5	40	75	292	10
18	35	15.5	40	75	302	10
19	35	15.5	40	75	312	10
20	35	15.5	40	75	323	10
21	38	15.5	40	75	330	10
22	38	22.5	40	75	340	10
24	38	22.5	40	75	362	10
27	38	22.5	40	75	402	10
30	38	28.5	40	75	445	10
32	38	28.5	40	75	485	10
36	42	28.5	40	75	663	10

## 6012M-75 Inhex Sockets Steckschlüssel für Innensechskant-Schrauben Douilles tournevis pour vis 6-pans creux

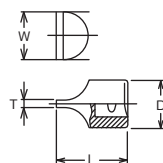

## 6101 Socket for Slotted Heads Steckschlüssel für Schlitzschrauben Douilles tournevis pour vis à fente



	TxW (mm)	D (mm)	L (mm)	 (g)	 (pcs.)
6101	6.4x33.5	35	50	205	5

Z-SERIES  
HAND  
TITANIUM  
SCREWDRIVERS ACCESSORIES  
IMPACT  
SLEEVE-DRIVE  
PROTECTOR  
INDUSTRIAL  
AUTOMOTIVE  
MOTORCYCLE  
CONSTRUCTION  
SPARE PART

**6749**  
**6749-1000** ⚠️  
**6749-HEAD**  
**PIPE-400 / -800**

Reversible Ratchet  
Knarre, verstellbar  
Cliquet, réversible



\* Renewal Kits → 6749RK → P318

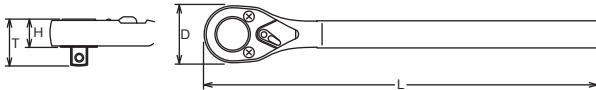

	D (mm)	T (mm)	H (mm)	L (mm)	(g)	(pce.)
6749	68	49.6	29.6	565	2840	1
6749-1000	68	49.6	29.6	965	3960	1
6749-HEAD	68	49.6	29.6	165	1730	1
PIPE-400	-	-	-	400	1110	1
PIPE-800	-	-	-	800	2230	1

⚠️ 6749-1000 has longer handle than standard, and can be loaded to excessive torque value. In the interest of your own safety always apply load evenly and progressively to avoid breakage and possible injury.

Der Gelenkgriff 6749-1000 ist länger als die Standardversion. Aus Gründen Ihrer Sicherheit, sollten dies Werkzeug nie ruckartig sondern nach und nach belastet werden, um Bruch und damit verbundene, mögliche Verletzungen zu vermeiden.

Le modèle 6749-1000 a une poignée plus longue que la norme et peut être soumis à un couple excessif. Pour votre sécurité, appliquez toujours la charge de manière uniforme et progressive afin d'éviter toute rupture et blessure.



**6752**  
**6752-HEAD**  
**PIPE-400**

Reversible Ratchet  
Knarre, verstellbar  
Cliquet, réversible



\* Renewal Kits → 6752RK → P319

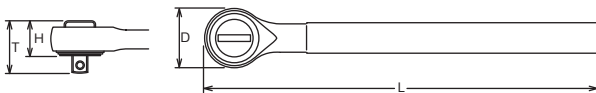

	D (mm)	T (mm)	H (mm)	L (mm)	(g)	(pce.)
6752	67	55.5	35.5	500	2360	1
6752-HEAD	67	55.5	35.5	100	1250	1
PIPE-400	-	-	-	400	1110	1



60

\* Renewal Kits → 6755RK → P319

	D (mm)	L (mm)	(g)	(pce.)
6755	62	97	1162	1

**6755** Ratchet Adaptor  
Aufsteckknarre  
Cliquet adaptable

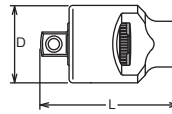

**6760** Extension Bars  
Verlängerungen  
Rallonges

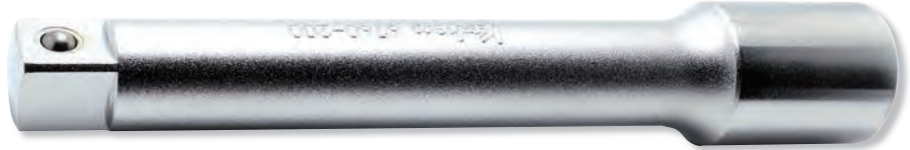

	D (mm)	d (mm)	L (mm)	(g)	(pce.)
6760-75	35	25	75	335	5
6760-100	35	25	100	434	2
6760-125	35	25	125	528	2
6760-150	35	25	150	624	2
6760-200	35	25	200	815	1
6760-300	35	25	300	1203	1
6760-400	35	25	400	1585	1

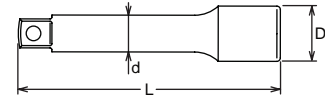

**6768** Hinge Handle  
Gelenkgriff  
Poignée articulée



\* Renewal Kits → 6768RK → P321

	D (mm)	L (mm)	(g)	(pce.)
6768	42	450	1715	1

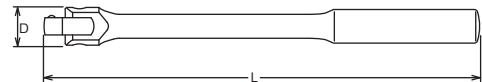

**6768-600 / -1000** ⚠ Hinge Handle  
**6768-HEAD** Gelenkgriff  
**PIPE-400 / -800** Poignée articulée



\* Renewal Kits → 6768RK → P321

6768	D (mm)	L (mm)	(g)	(pce.)
6768-600	42	600	2360	1
6768-1000	42	1000	3480	1
6768-HEAD	42	200	1250	1
PIPE-400	-	400	1110	1
PIPE-800	-	800	2230	1

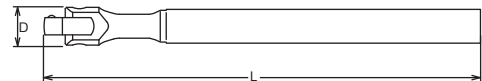

⚠ 6768-600/-1000 have longer handle than standard, and can be loaded to excessive torque value. In the interest of your own safety always apply load evenly and progressively to avoid breakage and possible injury.

Der Art. 6768-600/-1000 hat einen längeren Griff als die Standardausführung und kann mit einem zu hohen Drehmoment belastet werden. Bitte vorsichtig verwenden.

Les modèles 6768-600 et 6768-1000 ont une poignée plus longue que la norme et peuvent être soumis à un couple excessif. Pour votre sécurité, appliquez toujours la charge de manière uniforme et progressive afin d'éviter toute rupture et blessure.



Z-SERIES  
HAND  
TITANIUM  
SCREWDRIVERS ACCESSORIES  
IMPACT  
SLEEVE-DRIVE  
PROTECTOR  
INDUSTRIAL  
AUTOMOTIVE  
MOTORCYCLE  
CONSTRUCTION  
SPARE PART

**6785** T-Handle  
T-Griff  
Poignée coulissante

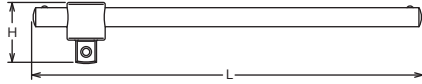

	H (mm)	L (mm)	(g)	(pce.)
<b>6785</b>	58	500	1542	1

**6788** L-Handle  
L-Griff  
Poignée en L



	L (mm)	(g)	(pce.)
<b>6788</b>	330	1175	1

**6770** Universal Joint  
Gelenk-Einsatz  
Cardan universel

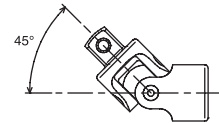
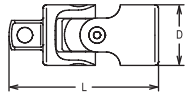

	D (mm)	L (mm)	(g)	(pcs.)
<b>6770</b>	36	105	478	2

**6644A** Adaptor  
Verbindungsstück  
Réducteur

Warranty 668Nm  
Garantie 668Nm  
Garantie 668Nm

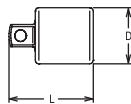

	(sq.)	(sq.)	D (mm)	L (mm)	(g)	(pcs.)
<b>6644A</b>	3/4"	1/2"	32	47	136	5
<b>6688A</b>	3/4"	1"	35	60	285	5

Adapting down from bigger square drive to smaller square drive may lead to excessive torque load and possibly cause breakage. Always stay within safe torque of the smaller square drive.

Die mit gekennzeichneten Artikel können bei Überbelastung zu Bruch gehen. Aus Gründen Ihrer eigenen Sicherheit sollten die betreffenden Werkzeuge nie ruckartig, sondern nach und nach belastet werden, um Bruch und damit verbundene mögliche Verletzungen zu vermeiden.

Le passage d'un entraînement carré plus grand à un entraînement carré plus petit peut entraîner une charge de couple excessive et provoquer une rupture. Respectez toujours le couple de sécurité de l'entraînement carré plus petit.

**6688A** Adaptor  
Verbindungsstück  
Augmentateur

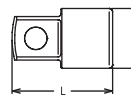

# 3/4" Hand Sockets Hand Steckschlüssel Douilles à main

**6201M-00** Socket Sets  
Steckschlüssel Sätze  
Jeu de clés à douille  
**6201A-00**  
**6201M-05**  
**6201A-05**



6201A-00	18 Pieces Set/△=17,600g
6201A-05	18 Pieces Set/△=17,600g
METAL CASE:W580xH200xT85mm	
Sockets	Accessories
(6201A-00) <b>6400A</b> 6-pt. Sockets 7/8, 15/16, 1.1/16, 1.1/8, 1.1/4, 1.5/16, 1.7/16, 1.1/2, 1.5/8, 1.11/16, 1.13/16, 1.7/8, 2	<b>6749</b> <b>6760-200</b> <b>6760-400</b> <b>6768</b>
(6201A-05) <b>6405A</b> 12-pt. Sockets 7/8, 15/16, 1.1/16, 1.1/8, 1.1/4, 1.5/16, 1.7/16, 1.1/2, 1.5/8, 1.11/16, 1.13/16, 1.7/8, 2	<b>6785</b>

6201M-00	16 Pieces Set/△=17,300g
6201M-05	16 Pieces Set/△=17,300g
METAL CASE:W580xH200xT85mm	
Sockets	Accessories
(6201M-00) <b>6400M</b> 6-pt. Sockets 22, 24, 27, 30, 32, 36, 41, 46, 50, 55, 60	<b>6749</b> <b>6760-200</b> <b>6760-400</b> <b>6768</b>
(6201M-05) <b>6405M</b> 12-pt. Sockets 22, 24, 27, 30, 32, 36, 41, 46, 50, 55, 60	<b>6785</b>

**6212M-00** Socket Sets  
Steckschlüssel Sätze  
Jeu de clés à douille  
**6212M-05**



6212M-00	12 Pieces Set/△=8,200g
6212M-05	12 Pieces Set/△=8,200g
METAL CASE:W580xH124xT70mm	
Sockets	Accessories
(6212M-00) <b>6400M</b> 6-pt. Sockets 22, 24, 27, 30, 32, 36, 41, 46, 50	<b>6749</b> <b>6760-200</b> <b>6785</b>
(6212M-05) <b>6405M</b> 12-pt. Sockets 22, 24, 27, 30, 32, 36, 41, 46, 50	

**8400M / 8400A**

6-point Sockets  
6-kant Steckschlüssel  
Douilles 6-pans

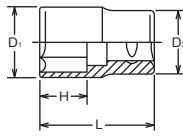

**8405M / 8405A**

12-point Sockets  
12-kant Steckschlüssel  
Douilles 12-pans

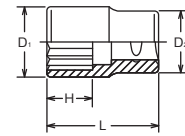
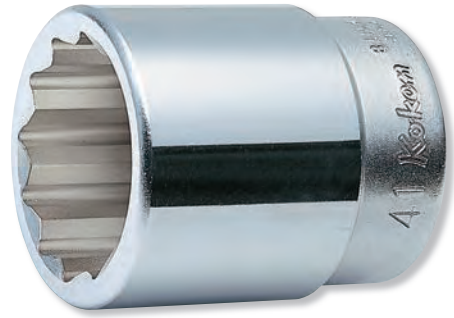

8400M 8405M (mm)	D <sub>1</sub> (mm)	D <sub>2</sub> (mm)	H (mm)	L (mm)	(g)	(pce.)
24	36.5	44	17	60	348	1
27	40.5	44	19	60	362	1
28	41.5	44	19.5	60	368	1
29	43	44	20	60	378	1
30	44	45	21	65	410	1
32	46.5	45	23	65	455	1
33	48	46	23.5	65	485	1
34	49	46	24	65	500	1
35	50.5	48	24.5	65	536	1
36	51.5	48	25	65	600	1
38	54	50	26	65	624	1
40	56.5	53	27	65	686	1
41	58	53	28	68	747	1
42	59	53	28.5	68	789	1
46	64	53	31	72	928	1
50	69	53	34	72	943	1
54	74	55	37	72	1016	1
55	75.5	53	42	77	1167	1
56	76.5	53	42	77	1160	1
58	79	53	41	77	1200	1
60	81.5	58	46	82	1440	1
63	85.5	58	45	82	1470	1
64	86.5	58	46	82	1540	1
65	88	63	49	86	1683	1
67	90.5	63	49	86	1840	1
68	91.5	63	49	86	1800	1
70	94	68	50	88	1963	1
71	95.5	68	50	88	2200	1
75	100.5	73	53	90	2204	1
78	104	75	52.5	90	2500	1
80	106.5	75	58	95	2550	1
83	110.5	78	57	95	2730	1
85	113	80	57	95	2680	1
90	119	80	59	100	3420	1
95	125.5	85	58	100	4900	1
100	131.5	85	57	100	4840	1

8400A 8405A (inch)	D <sub>1</sub> (mm)	D <sub>2</sub> (mm)	H (mm)	L (mm)	(g)	(pce.)
15/16	36.5	44	17	60	355	1
1. 3/16	44	45	21	65	410	1
1. 1/4	46.5	45	23	65	455	1
1. 5/16	48	46	23.5	65	485	1
1. 3/8	50.5	48	24.5	65	536	1
1. 7/16	53	50	25.5	65	607	1
1. 1/2	54	50	26	65	624	1
1. 9/16	56.5	53	27	65	686	1
1. 5/8	58	53	28	68	747	1
1.11/16	60.5	53	29	68	830	1
1. 3/4	61.5	53	29.5	68	807	1
1.13/16	64	53	31	72	928	1
1. 7/8	66.5	53	32	72	936	1
1.15/16	68	53	32.5	72	941	1
2	70.5	53	37	72	976	1
2. 1/16	73	54	37	72	1027	1
2. 1/8	74	55	37	72	1016	1
2. 3/16	76.5	53	41	77	1192	1
2. 1/4	78	53	41	77	1177	1
2. 5/16	80.5	53	41	77	1292	1
2. 3/8	81.5	58	46	82	1440	1
2. 7/16	84	58	45	82	1495	1
2. 1/2	86.5	58	45	82	1497	1
2. 9/16	88	63	49	86	1683	1
2. 5/8	90.5	63	49	86	1840	1
2.11/16	91.5	63	49	86	1800	1
2. 3/4	94	68	50	88	1963	1
2.13/16	96.5	68	50	88	2035	1
2. 7/8	98	70	50	88	2100	1
2.15/16	100.5	73	53	90	2204	1
3	103	75	53	90	2406	1
3. 1/8	106.5	75	58	95	2550	1
3. 1/4	110.5	78	57	95	2730	1
3. 3/8	114	80	57	95	3050	1
3. 1/2	119	80	59	100	3420	1
3. 3/4	125.5	85	58	100	4900	1

8012M-80 (mm)	D (mm)	H <sub>1</sub> (mm)	H <sub>2</sub> (mm)	L (mm)	(g)	(pcs.)
17	44.2	15.5	45	80	400	5
19	44.2	15.5	45	80	410	5
22	47.9	22.5	45	80	436	5
24	47.9	22.5	45	80	471	5
27	47.9	22.5	45	80	526	5
30	47.9	22.5	45	80	658	5
32	47.9	22.5	45	80	715	5
36	54.2	22.5	45	80	945	5

## 8012M-80

**Inhex Sockets**  
Steckschlüssel für Innensechskant-Schrauben  
Douilles tournevis pour vis 6-pans creux

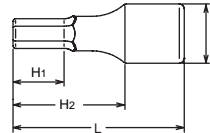

## 8760

**Extension Bars**  
Verlängerungen  
Rallonges



	D (mm)	d (mm)	L (mm)	(g)	(pcs.)
8760-200	44	32	200	1300	1
8760-400	44	32	400	2570	1

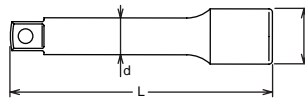

	D (mm)	L (mm)	(g)	(pcs.)
8770	48	143	1170	1

## 8770

**Universal Joint**  
Gelenk-Einsatz  
Cardan universel

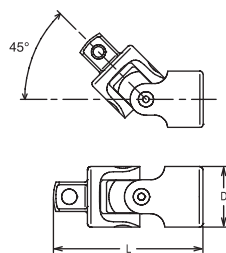

	(sq.)	(sq.)	D (mm)	L (mm)	(g)	(pcs.)
8866A	1"	3/4"	44	60	338	5

**⚠** Adapting down from bigger square drive to smaller square drive may lead to excessive torque and possibly cause breakage.

Reduzierstücke sind mit Vernunft einzusetzen.

Es besteht Bruchgefahr. Überschreiten Sie niemals die Sicherheitsgrenzen.

Le passage d'un entraînement carré plus grand à un entraînement carré plus petit peut entraîner une charge de couple excessive et provoquer une rupture.

## 8866A

**Adaptor**  
Verbindungsstück  
Réducteur

Warranty 1850Nm  
Garantie 1850Nm  
Garantie 1850Nm **⚠**

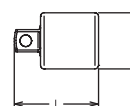

Z-SERIES  
HAND  
TITANIUM  
ACCESSORIES  
SCREWDRIVERS  
IMPACT  
SLEEVE-DRIVE  
PROTECTOR  
INDUSTRIAL  
AUTOMOTIVE  
MOTORCYCLE  
CONSTRUCTION  
SPARE PART

**8749**  
**8749-1000** ⚠️  
**8749-HEAD**  
**PIPE-580 / -800**

Reversible Ratchet  
Knarre, verstellbar  
Cliquet, réversible



\* Renewal Kits → **8749RK** → P318

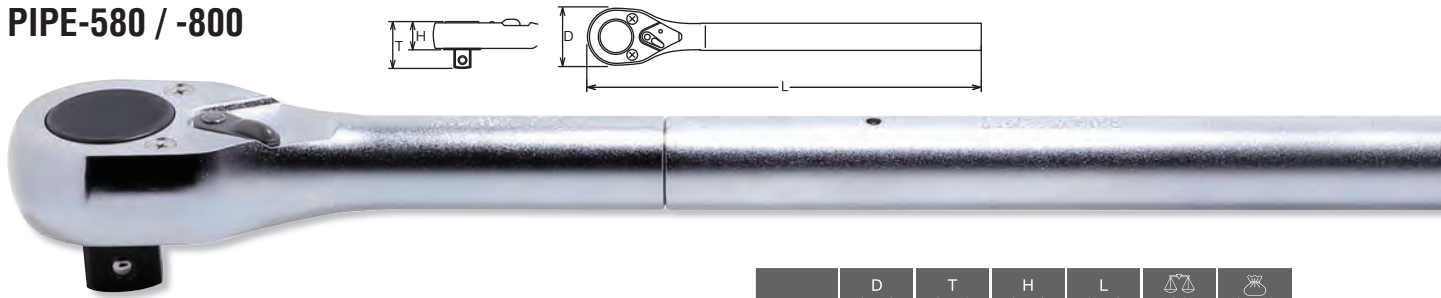

⚠️ 8749-1000 has longer handle than standard, and can be loaded to excessive torque value. In the interest of your own safety always apply load evenly and progressively to avoid breakage and possible injury.

Der Art. 8749-1000 hat einen längeren Griff als die Standardausführung und kann mit einem zu hohen Drehmoment belastet werden. Bitte vorsichtig verwenden.

Le modèle 8749-1000 a une poignée plus longue que la norme et peut être soumis à un couple excessif. Pour votre sécurité, appliquez toujours la charge de manière uniforme et progressive afin d'éviter toute rupture et blessure.

	D (mm)	T (mm)	H (mm)	L (mm)	(g)	(pce.)
<b>8749</b>	70	62.2	36.2	800	4100	1
<b>8749-1000</b>	70	62.2	36.2	1020	4720	1
<b>8749-HEAD</b>	70	62.2	36.2	220	2490	1
<b>PIPE-580</b>	-	-	-	580	1610	1
<b>PIPE-800</b>	-	-	-	800	2230	1

**8768**  
**8768-1000** ⚠️  
**8768-HEAD**  
**PIPE-400 / -800**

Hinge Handle  
Gelenkgriff  
Poignée articulée



⚠️ 8768-1000 has longer handle than standard, and can be loaded to excessive torque value. In the interest of your own safety always apply load evenly and progressively to avoid breakage and possible injury.

Der Art. 8768-1000 hat einen längeren Griff als die Standardausführung und kann mit einem zu hohen Drehmoment belastet werden. Bitte vorsichtig verwenden.

Le modèle 8768-1000 a une poignée plus longue que la norme et peut être soumis à un couple excessif. Pour votre sécurité, appliquez toujours la charge de manière uniforme et progressive afin d'éviter toute rupture et blessure.

\* Renewal Kits → **8768RK** → P321

	D (mm)	L (mm)	(g)	(pce.)
<b>8768</b>	55	600	2590	1
<b>8768-1000</b>	55	1000	3710	1
<b>8768-HEAD</b>	55	200	1480	1
<b>PIPE-400</b>	-	400	1110	1
<b>PIPE-800</b>	-	800	2230	1

**8785**  
**8785-700**

T-Handle  
T-Griff  
Poignée coulissante

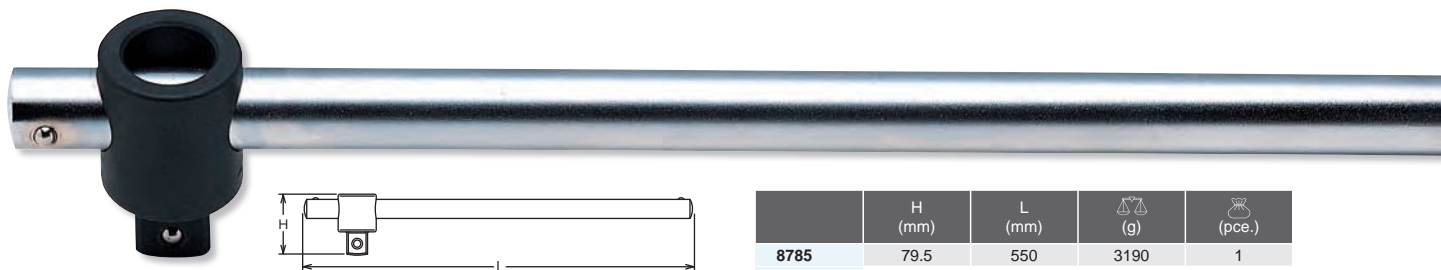

	H (mm)	L (mm)	(g)	(pce.)
<b>8785</b>	79.5	550	3190	1
<b>8785-700</b>	79.5	700	3906	1

**8788**  
L-Handle  
L-Griff  
Poignée en L

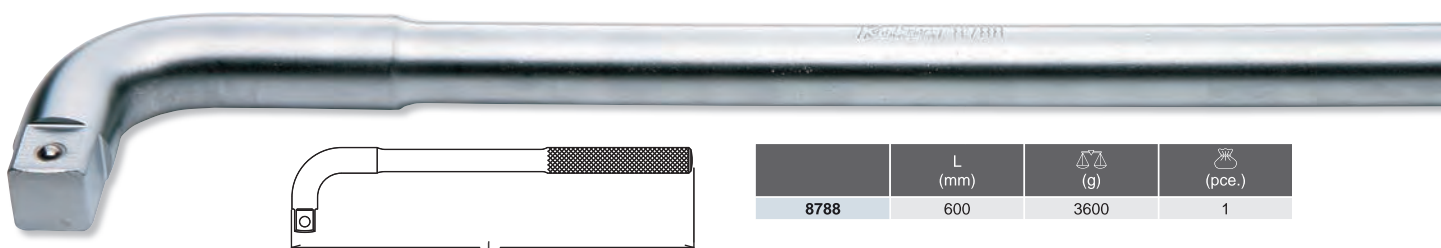

	L (mm)	(g)	(pce.)
<b>8788</b>	600	3600	1

# 1”

Hand Sockets  
Hand Steckschlüssel  
Douilles à main

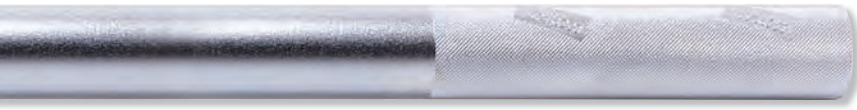

Z-SERIES  
HAND  
TITANIUM  
ACCESSORIES  
SCREWDRIVERS  
IMPACT  
SLEEVE-DRIVE  
PROTECTOR  
INDUSTRIAL  
AUTOMOTIVE  
MOTORCYCLE  
CONSTRUCTION  
SPARE PART

Hand Sockets  
Hand Steckschlüssel 1"  
Douilles à main



**8225M-00** Socket Sets  
Steckschlüssel Sätze  
Jeu de clés à douille

**8225M-05**



8225M-00 15 Pieces Set/重量=27,000g  
8225M-05 15 Pieces Set/重量=27,000g

METAL CASE:W600xH217xT97mm

Sockets	Accessories
(8225M-00) <b>8400M</b> 6-pt. Sockets 32, 33, 36, 41, 46, 50, 55, 60, 65, 70, 75, 80	 <b>8749</b>
(8225M-05) <b>8405M</b> 12-pt. Sockets 32, 33, 36, 41, 46, 50, 55, 60, 65, 70, 75, 80	 <b>8760-200</b>
	 <b>8760-400</b>

