

**Z-SERIES  
Z-SERIE  
SERIES-Z**



# Koken Z-series



## Z series - Evolution of Automotive service Lineup

Z-series MOVIE

### - CONCEPT -

Continued advancements in engine designs and structures are producing engines that are more complex and compact. Work environments are being transformed to cater towards increased demands on auto mechanics.

We at Ko-ken TOOL CO., LTD., specialists in socket wrench manufacturing, have been committed to the development of automotive tools that are more suitable by pouring in our passion for perfecting hand tools and utilizing our experience obtained through over half a century of manufacturing to create the Z series.

"Z" stands for "zeal". Through their unequaled performance, Z-Series tools are certain to become the mechanic's new standard for the next generation of automotive tools.

### - Konzept -

Der ständige Fortschritt im Motorenbau führt zu immer komplexeren und kompakteren Motoren.

Die Arbeitsmittel für den Automechaniker sollten auf diese neuen Anforderungen ausgerichtet sein.

Wir, Ko-ken TOOL CO., LTD. als Spezialisten in der Herstellung von Steckschlüsseln, fühlen uns im besonderen Maße verpflichtet Werkzeuge zur Verfügung zu stellen, die diesen ständig veränderten Anforderungen gerecht werden.

Unsere langjährige Erfahrung und unser absoluter Wille zur Perfektion halfen uns bei der Entwicklung der neuen Z-Serie.

Das „Z“ steht hier für das englische Wort ZEAL (Begeisterung).

Durch ihre beispiellose Leistung werden die Werkzeuge der Z-Serie zum neuen Standard der nächsten Generation von KFZ-Werkzeugen.

### - Concept -

L'évolution continue des moteurs en matière de performance et design fait qu'ils deviennent de plus en plus complexes et compacts.

De ce fait, l'environnement de travail du mécanicien doit être adapté.

Chez Ko-ken TOOL CO., LTD., spécialiste dans la fabrication des clés à douilles, nous nous sommes dévoués à optimiser le travail du mécanicien en lui fournissant le parfait outil. C'est avec l'expérience d'un demi-siècle dans la production de l'adaptation à la demande du marché que nous avons réussi à développer la série „Z“.

„Z“ vient du mot anglais „Zeal“, ce qui signifie enthousiasme. De manière inédite, les douilles de la série „Z“ deviendront le nouveau outil standard pour le mécanicien de demain.

### - OVERALL - - Allgemein - - Généralités -



#### • Designed for best performance

The designs were thoroughly reviewed to produce the Z-series.

All items in this series are now more compact.

Foregoing standards, radical design concepts have been implemented in producing the Z series which enables maximum potential in all professional mechanics.

#### • Konzipiert für eine bessere Leistung

Das Design der Z-Serie wurde komplett überdacht. Alle Artikel dieser Serie sind im Allgemeinen kompakter als die herkömmlichen Steckschlüssel.

Zukunftsweisende Standards und innovative Designkonzepte sorgen für ein optimiertes Anwendungspotenzial für den professionellen Mechaniker.

#### • Élaborée pour une meilleure performance

Un nouveau design a été spécialement conçu pour la série Z. Tous les articles sont plus compacts par rapport aux douilles normales.

Un standard futuriste et une conception innovatrice garantissent un usage optimal au mécanicien professionnel.

#### • Tolerance – Square drive

Movement at the joint between a socket and a ratchet or other drive accessory has been accepted as unavoidable.

To reduce this movement, we thoroughly reviewed dimensional accuracy of all the joint parts of Z-Series, and any movement in the rotating direction has now been minimized through production technologies.

#### • Toleranz Antriebsvierkante

Das Spiel an den Verbindungsstellen zwischen Steckschlüssel und Knarre oder zwischen anderen Betätigungselementen wurde bisher als unvermeidbar angesehen.

Um dieses Spiel zu verringern wurden die Toleranzen aller möglichen Verbindungsstellen bei der Z-Serie verringert.

Durch besondere Produktionstechniken wurde erreicht, dass es nun kaum noch Spiel in der Rotationsachse der Verbindungen mehr gibt.

#### • Tolérance – carré entraînant

Depuis toujours le jeu inévitable lors du raccord entre la douille et le cliquet, ou tout autre accessoire, a été déclaré comme inévitable.

Pour réduire ce jeu, nous avons vérifié à fond l'exactitude des dimensions sur les raccords et grâce à notre technologie de production les rotations possibles ont pu être minimisées pour la série „Z“.

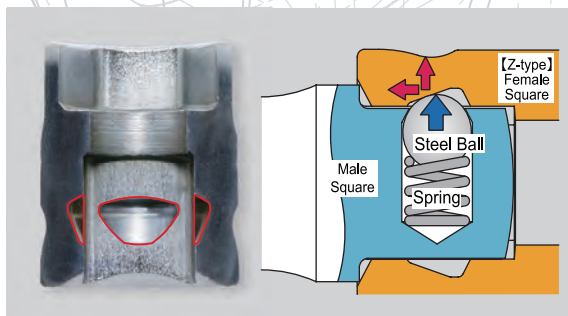
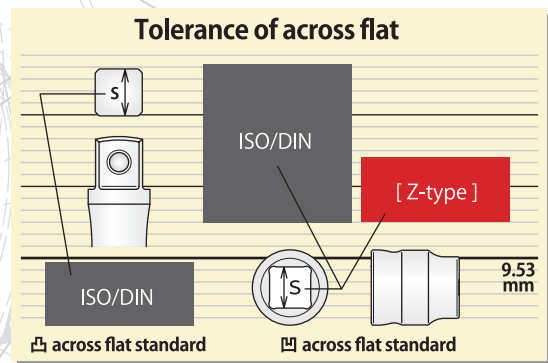

#### • Ball Holding Groove

The new Ball Holding Groove was installed. Any movement in the connecting direction has been reduced by a mechanism that pulls the parts together.

#### • Kugelfang

Die Werkzeuge der Z-Serie verfügen über spezielle Kugelfangrillen die eine noch sicherere Verbindung zwischen Betätigungswerkzeug und Steckschlüssel gewährleisten.

#### • Rainure pour bille

Un nouveau système de rainure pour bille a été installé. Tout mouvement dans le raccordement a été réduit par un mécanisme qui tire sur les parties raccordantes.

**- REVERSIBLE RATCHET - - Knarre, verstellbar - - Cliquet, réversible -**

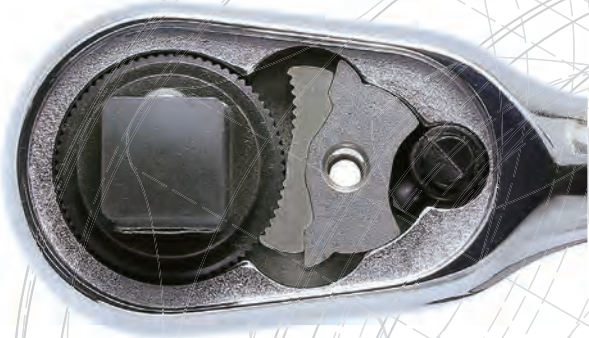

**• 72 tooth gear Ratchet Handle - Light Ratchet Movement**

This ratchet handle has a new mechanism for enhanced usability. This Ratchet has incredibly light turning torque that enables working on loosely tightened bolts. With the compact head and balanced design, the Z-Series ratchet has evolved into what can be called the "ideal ratchet handle".

**• Leichtgängiger 72 Zahn Knarren Mechanismus**

Diese Knarre verfügt über ein neues, sehr leichtgängige Getriebe mit 72 Zähnen. Nach dem Lösen der Schraube genügt meist deren Gewindereibung um den Mechanismus der Knarre auszulösen. Das ausgeglichene Design und der kompakte Knarrenkopf machen die Knarren der Z-Serie zur idealen Knarre.

**• Cliquet à manche à 72 dents – cliquet à mouvement facile**

Ce cliquet dispose d'un mécanisme à 72 dents permettant un usage élargi dû au mouvement facile du cliquet. Pour nous, les cliquets de la série „Z“ avec leurs têtes compactes et le design équilibré, sont les „cliquets à manche idéaux“.

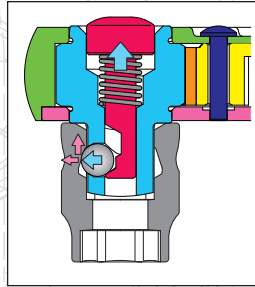
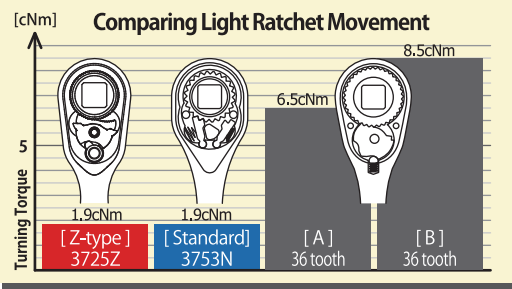

A, B : Other brand

**• Push release : Locking type**

Innovative new locking mechanism is installed. This new mechanism achieved both of locking a socket and also unique feature of Z-series pulls parts together for tight connection.

**• Knarre verstellbar mit Entriegelungsknopf**

Der neue Mechanismus sorgt sowohl für einen sicheren Halt, als auch für einen fast spielfreien Sitz des Steckschlüssels auf dem Antriebsvierkant. Dies ist einzigartig bei der Z-Serie.

**• Manche du cliquet**

Le nouveau mécanisme assure un maintien sûr des douilles ainsi qu'un verrouillage presque sans jeu sur l'entraînement carré, une caractéristique unique de la série Z.



**- SOCKETS - - Steckschlüssel - - Douilles -**

**• Compact**

The length and diameter of sockets have been significantly reduced. Ideal for working in confined and tight areas.

**• Kompakt**

Die Gesamtlänge und der Aussendurchmesser der Steckschlüssel wurden stark reduziert, dies erlaubt ein Arbeiten an schwer zugänglichen Stellen.

**• Compact**

La longueur intégrale et le diamètre des douilles sont remarquablement réduits, ce qui permet de travailler dans des endroits étroits ou difficilement accessibles.

**• Tolerance -Hexagon Opening.**

Foregoing the ISO and DIN standards, radical design concepts have been implemented in producing the Z series which enables maximum potential in all professional mechanics.

**• Toleranzen der 6-kant Öffnungen**

Bewährte Standards nach (DIN und ISO) einhaltend und innovative Design Konzepte sorgen für ein optimiertes Anwendungspotenzial für den professionellen Mechaniker.

**• Tolérances des ouvertures hexagonales**

Un standard préalable (ISO et DIN) et une conception innovante sont implantés dans la production des produits „Z“ pour en sortir un potentiel de travail maximal pour le mécanicien professionnel.

**- Comparison of 10mm Sockets-**

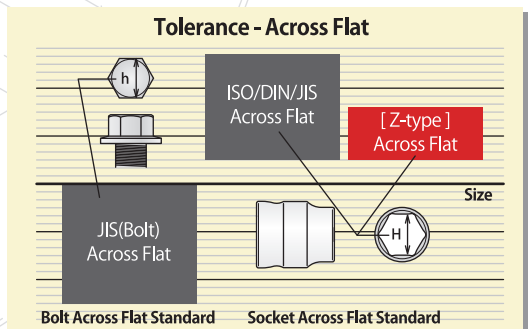
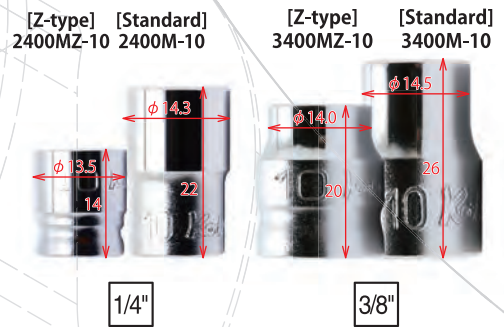

## 2400MZ



6-point Sockets  
6-kant Steckschlüssel  
Douilles 6-pans

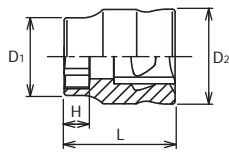

2400MZ (mm)	D <sub>1</sub> (mm)	D <sub>2</sub> (mm)	H (mm)	L (mm)	(g)	(pcs.)
4	6.4	11	3	14	6	10
4.5	7	11	3	14	6	10
5	7.6	11	3	14	6	10
5.5	8.2	11	3.5	14	6	10
6	8.8	11	3.5	14	6	10
7	9.9	11	3.5	14	6	10
8	11.1	11.7	4.5	15	7	10
10	13.5	12.5	7	15	8	10
11	14.7	13.2	7	15	9	10
12	15.9	14.4	7	15	11	10
13	17.1	15.6	7	15	14	10
14	18.3	16.8	7	15	16	10

## RS2400MZ/12



Socket Set on magnetic Rail  
Steckschlüsselsatz auf Magnetschiene  
Jeu de douilles sur rail à aimant



RS2400MZ/12	12 Pieces Set/Rail 200mm	(g)
4, 4.5, 5, 5.5, 6, 7, 8, 10, 11, 12, 13, 14		228

## 2300XZ



6-point Sockets, Semi-Deep  
6-kant Steckschlüssel, mittel-lang  
Douilles, semi-profondes 6-pans

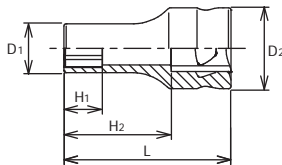

2300XZ (mm)	D <sub>1</sub> (mm)	D <sub>2</sub> (mm)	H <sub>1</sub> (mm)	H <sub>2</sub> (mm)	L (mm)	(g)	(pcs.)
5.5	8.2	11	6	20	30	10	10
6	8.8	11	7	20	30	10	10
7	9.9	11	8	20	30	11	10
8	11.1	11.7	9	20	30	13	10
10	13.5	12.5	11	20	30	16	10
11	14.7	13.2	12	20	30	19	10
12	15.9	14.4	13	20	30	22	10
13	17.1	15.6	14	20	30	26	10
14	18.3	16.8	14	20	30	30	10

## RS2300XZ/9



Socket Set on magnetic Rail  
Steckschlüsselsatz auf Magnetschiene  
Jeu de douilles sur rail à aimant



RS2300XZ/9	9 Pieces Set/Rail 200mm	(g)
5.5, 6, 7, 8, 10, 11, 12, 13, 14		290

## 2300MZ



6-point Deep Sockets  
6-kant-Steckschlüssel, lang  
Douilles longues 6-pans

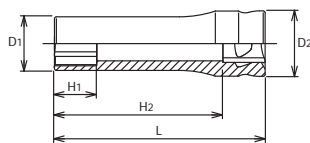

2300MZ (mm)	D <sub>1</sub> (mm)	D <sub>2</sub> (mm)	H <sub>1</sub> (mm)	H <sub>2</sub> (mm)	L (mm)	(g)	(pcs.)
4	6.4	11	5	41	50	14	10
4.5	7	11	5.5	41	50	16	10
5	7.6	11	6	41	50	16	10
5.5	8.2	11	6.5	41	50	16	10
6	8.8	11	7	41	50	17	10
7	9.9	11	8	41	50	20	10
8	11.1	11.7	9	41	50	22	10
10	13.5	12.5	11	41	50	29	10
11	14.7	13.2	12	41	50	33	10
12	15.9	14.4	13	41	50	40	10
13	17.1	15.6	14	41	50	45	10
14	18.3	16.8	16	41	50	51	10

## RS2300MZ/12



Socket Set on magnetic Rail  
Steckschlüsselsatz auf Magnetschiene  
Jeu de douilles sur rail à aimant



RS2300MZ/12	12 Pieces Set/Rail 200mm	(g)
4, 4.5, 5, 5.5, 6, 7, 8, 10, 11, 12, 13, 14		445

# 1/4"

Z-series  
Z-serie  
Series-Z

2441MZ (mm)	D <sub>1</sub> (mm)	D <sub>2</sub> (mm)	H (mm)	L (mm)	(g)	(pcs.)
8	12.3	11.7	4.5	30.5	18	10
10	14.3	11.7	4.5	30.5	20	10
12	16.8	11.7	5.5	31.5	25	10
13	18	11.7	5.5	31.5	27	10
14	20	11.7	7	33	31	10



**2441MZ** Nut Grip Universal Sockets **Nut Grip®**  
Gelenk-Einsätze mit zweifacher Kugelhalterung  
Douilles articulées à billes de retenue

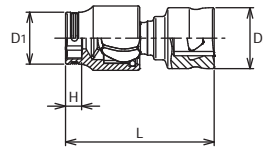

RS2441MZ/5	5 Pieces Set/Rail 200mm	(g)
New	8, 10, 12, 13, 14	235

**RS2441MZ/5** Socket Set on magnetic Rail  
Steckschlüsselsatz auf Magnetschiene  
Jeu de douilles sur rail à aimant



2000Z-28 (PH)	D (mm)	H (mm)	L (mm)	(g)	(pcs.)
1	11.2	12	28	9	10
2	11.2	12	28	10	10
3	11.2	12	28	10	10

2000Z-50 (PH)	D (mm)	d (mm)	H (mm)	L (mm)	(g)	(pcs.)
1	11.2	4	34	50	11	10
2	11.2	5	34	50	13	10
3	11.2	-	34	50	16	10

**2000Z-28 / -50** PH Bit Sockets  
Steckschlüssel für Kreuzschlitzschrauben, PH  
Douilles tournevis pour vis à empreinte PH

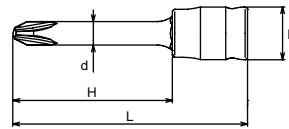

2005Z-25	T x W (mm)	D (mm)	H (mm)	L (mm)	(g)	(pcs.)
5	1.0 x 5.5	11.2	9	25	9	10
6	1.2 x 6.5	11.2	9	25	10	10

**2005Z-25** Bit Sockets for Slotted Head  
Steckschlüssel für Schlitzschrauben  
Douilles tournevis pour vis à fente

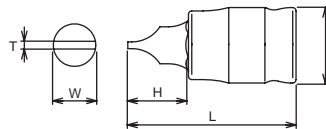

2010MZ-25 (mm)	D (mm)	H <sub>1</sub> (mm)	H <sub>2</sub> (mm)	L (mm)	(g)	(pcs.)
New 2	11.2	4	9	25	9	10
New 2.5	11.2	5	9	25	9	10
3	11.2	5.5	9	25	9	10
4	11.2	6.1	9	25	9	10
5	11.2	6.8	9	25	10	10
6	11.2	7.1	9	25	10	10

**2010MZ-25 / -50** Inhex Bit Sockets  
Steckschlüssel für Innensechskant-Schrauben  
Douilles tournevis pour vis 6-pans creux

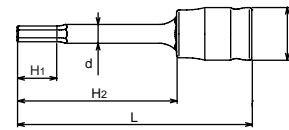

2010MZ-50 (mm)	D <sub>1</sub> (mm)	d (mm)	H <sub>1</sub> (mm)	H <sub>2</sub> (mm)	L (mm)	(g)	(pcs.)
New 2	11.2	3	4	34	50	10	10
New 2.5	11.2	3.5	5	34	50	11	10
3	11.2	4	8.5	34	50	11	10
4	11.2	5	8.5	34	50	13	10
5	11.2	6	8.5	34	50	15	10
6	11.2	-	8.5	34	50	17	10

**RS2010MZ/6-L25** Socket Set on magnetic Rail  
**RS2010MZ/6-L50** Steckschlüsselsatz auf Magnetschiene  
Jeu de douilles sur rail à aimant



RS2010MZ/6-L25	6 Pieces Set/Rail 200mm	(g)
New	2, 2.5, 3, 4, 5, 6	170

RS2010MZ/6-L50	6 Pieces Set/Rail 200mm	(g)
New	2, 2.5, 3, 4, 5, 6	195

Z-SERIES  
HAND  
TITANIUM  
ACCESSORIES  
SCREWDRIVERS  
IMPACT  
SLEEVE-DRIVE  
PROTECTOR  
INDUSTRIAL  
AUTOMOTIVE  
MOTORCYCLE  
CONSTRUCTION  
SPARE PART

## RS20XXZ/9



Socket Set on magnetic Rail  
Steckschlüsselsatz auf Magnetschiene  
Jeu de douilles sur rail à aimant



RS20XXZ/9		9 Pieces Set/Rail 200mm	(g)
2000Z.28		1, 2, 3	213
2005Z.25		5, 6	
2010MZ.25		3, 4, 5, 6	

## 2025Z-28 / -50



TORX® Bit Sockets  
TORX® Bit-Steckschlüssel  
Douilles tournevis, TORX®

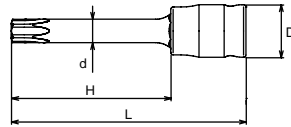

2025Z-28 (T)	D (mm)	H (mm)	L (mm)	(g)	(pcs.)
T10	11.2	12	28	9	10
T15	11.2	12	28	9	10
T20	11.2	12	28	9	10
T25	11.2	12	28	10	10
T27	11.2	12	28	10	10
T30	11.2	12	28	10	10
T40	11.2	12	28	11	10

2025Z-50 (T)	D (mm)	d (mm)	H (mm)	L (mm)	(g)	(pcs.)
T10	11.2	4	34	50	11	10
T15	11.2	4	34	50	11	10
T20	11.2	4.5	34	50	12	10
T25	11.2	5	34	50	13	10
T27	11.2	5	34	50	13	10
T30	11.2	5.6	34	50	15	10
T40	11.2	-	34	50	17	10

## RS2025Z/7-L28 RS2025Z/7-L50



Socket Set on magnetic Rail  
Steckschlüsselsatz auf Magnetschiene  
Jeu de douilles sur rail à aimant



RS2025Z/7-L28		7 Pieces Set/Rail 200mm	(g)
		T10, T15, T20, T25, T27, T30, T40	195

RS2025Z/7-L50		7 Pieces Set/Rail 200mm	(g)
		T10, T15, T20, T25, T27, T30, T40	220

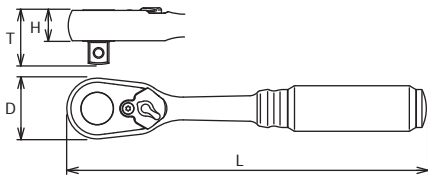

72

**2725Z** Reversible Ratchet  
Knarre, verstellbar  
Cliquet, réversible



	D (mm)	T (mm)	H (mm)	L (mm)	(g)	(pce.)
<b>2725Z</b>	20.5	17.1	9.5	114	79	1

\* Renewal Kits → 2725RK-2 → P320

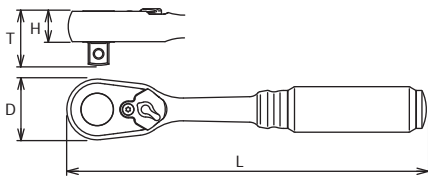

72

**2725Z-160** Reversible Ratchet  
Knarre, verstellbar ⚠  
Cliquet, réversible



	D (mm)	T (mm)	H (mm)	L (mm)	(g)	(pce.)
<b>2725Z-160</b>	20.5	17.1	9.5	160	115	1

\* Renewal Kits → 2725RK-2 → P320

⚠ 2725Z-160 have longer handle than standard, and can be loaded to excessive torque value. In the interest of your own safety always apply load evenly and progressively to avoid breakage and possible injury.

Sie haben einen längeren Griff als Standardprodukte und können mit einem übermäßigen Drehmoment belastet werden. Im Interesse Ihrer eigenen Sicherheit sollten Sie sie immer gleichmäßig und schrittweise belasten, um Brüche und mögliche Verletzungen zu vermeiden.

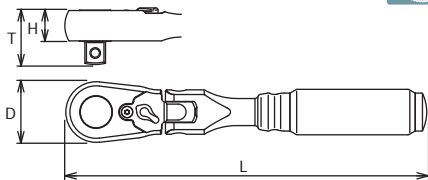

72  Flexible Head

**2726Z** Flexible Ratchet, Reversible (Short)  
Gelenk-Knarre kurz, verstellbar  
Cliquet articulé court, réversible



	D (mm)	T (mm)	H (mm)	L (mm)	(g)	(pce.)
<b>2726Z</b>	20.5	17.1	9.5	114	103	1

\* Renewal Kits → 2725RK-2 → P320

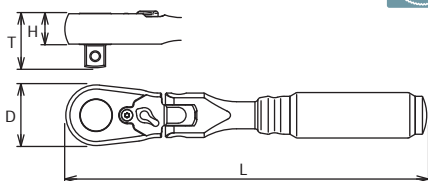

72  Flexible Head

**2726Z-160** Flexible Ratchet, Reversible (long) ⚠  
Gelenk-Knarre lang, verstellbar  
Cliquet articulé long, réversible



⚠ 2726Z-160 have longer handle than standard, and can be loaded to excessive torque value. In the interest of your own safety always apply load evenly and progressively to avoid breakage and possible injury.

Sie haben einen längeren Griff als Standardprodukte und können mit einem übermäßigen Drehmoment belastet werden. Im Interesse Ihrer eigenen Sicherheit sollten Sie sie immer gleichmäßig und schrittweise belasten, um Brüche und mögliche Verletzungen zu vermeiden.

	D (mm)	T (mm)	H (mm)	L (mm)	(g)	(pce.)
<b>2726Z-160</b>	20.5	17.1	9.5	160	125	1

\* Renewal Kits → 2725RK-2 → P320

## 2760Z

Extension Bars  
Verlängerungen  
Rallonges

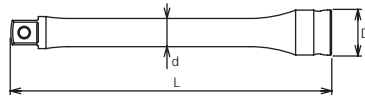

	D (mm)	d (mm)	L (mm)	(g)	(pcs.)
2760Z-50	11.5	7.8	50	21	10
2760Z-100	11.5	7.8	100	39	10
2760Z-150	11.5	7.8	150	58	10

## 2771Z

Universal Joint  
Gelenk-Einsatz  
Joint articulé

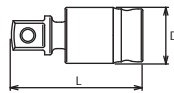

	D (mm)	L (mm)	(g)	(pcs.)
2771Z	11.7	29.9	15	10

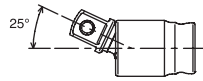

## 2772Z

Universal Double Joint  
Doppelgelenk-Einsatz  
Joint articulé double

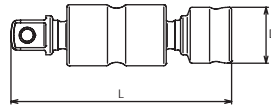

	D (mm)	L (mm)	(g)	(pcs.)
2772Z	11.7	46	26	10

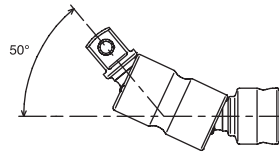

## 2756Z

Quick Spinner  
Rändel-Drehscheibe  
Lanceur



	D (mm)	L (mm)	(g)	(pcs.)
2756Z	20.3	18	15	10

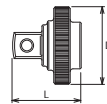

## 2756Z-3/8

Quick Spinner, Adaptor  
Rändel-Drehscheibe als Adaptor  
Lanceur, adaptateur



2756Z-3/8

2756Z-1/2



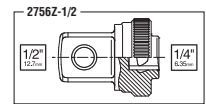
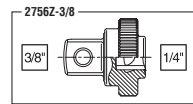
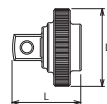







	D (mm)	L (mm)	(g)	(pcs.)
2756Z-3/8	20.3	21.5	24	10
2756Z-1/2	20.3	26	35	10

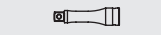

# 1/4"

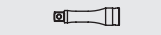

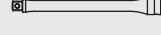

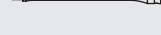
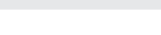





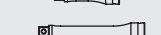

Z-series  
Z-serie  
Series-Z

Z-SERIES  
HAND  
TITANIUM  
ACCESSORIES  
SCREWDRIVERS  
IMPACT  
SLEEVE-DRIVE  
PROTECTOR  
INDUSTRIAL  
AUTOMOTIVE  
MOTORCYCLE  
CONSTRUCTION  
SPARE PART

P2285Z		26 Pieces Set/△=660g	
PLASTIC CASE:W245xH120xT45			
Sockets	Accessories		
 <b>2400MZ</b> 6-pt. Sockets 4, 4.5, 5, 5.5, 6, 7, 8, 10, 11, 12, 13, 14			<b>2725Z</b>
			<b>2756Z</b>
 <b>2000Z.28</b> 1, 2, 3			<b>2771Z</b>
 <b>2005Z.25</b> 5, 6			<b>2760Z-50</b>
 <b>2010MZ.25</b> 3, 4, 5, 6			<b>2760Z-150</b>





**P2285Z** Set in PE-foam tray  
Steckschlüsselsatz in Weichschaumeinlage  
Set disposé dans boîte de rangement en mousse souple



2286Z		17 Pieces Set/△=780g	
BLACK METAL CASE:W240xH100xT32mm			
Sockets	Accessories		
 <b>2400MZ</b> 6-pt. Sockets 4, 5, 5.5, 6, 7, 8, 10, 11, 12, 13, 14			<b>2725Z</b>
			<b>2756Z</b>
			<b>2771Z</b>
			<b>2760Z-50</b>
			<b>2760Z-100</b>
			<b>2760Z-150</b>

**2286Z** Set in PE-foam tray  
Steckschlüsselsatz in Weichschaumeinlage  
Set disposé dans boîte de rangement en mousse souple



2285ZE		10 Pieces Set/△=300g	
Rail 200mm/CARDBOARD BOX			
Sockets	Accessories		
 <b>2400MZ</b> 6-pt. Sockets 5.5, 6, 7, 8, 10, 12, 13, 14			<b>2725Z</b>
			<b>2756Z</b>

**2285ZE** Socket Set on magnetic Rail  
Steckschlüsselsatz auf Magnetschiene  
Jeu de douilles sur rail à aimant



## 3400MZ

6-point Sockets  
6-kant Steckschlüssel  
Douilles 6-pans

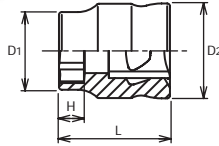

3400MZ (mm)	D <sub>1</sub> (mm)	D <sub>2</sub> (mm)	H (mm)	L (mm)	(g)	(pcs.)
5.5	8.5	17	3.5	19	16	10
6	9.1	17	3.5	19	17	10
7	10.3	17	3.5	19	17	10
8	11.5	17	4.5	20	17	10
10	14	17	4.5	20	18	10
11	15.3	17	5.5	21	18	10
12	16.5	17	5.5	21	19	10
13	17.8	17	8.5	21	19	10
14	19	17	8.5	21	20	10
15	20.2	18.2	8.5	21	24	10
16	21.3	19.3	8.5	21	28	10
17	22.5	20.5	8.5	21	32	10
18	23.6	21.6	9.5	22	38	10
19	24.8	22.8	9.5	22	41	10
21	27	25	10.5	23	51	10
22	28.3	26.3	10.5	23	58	10

3400MZ is designed 5-9mm shorter than standard 3400M.  
Ideal for working in confined and tight areas.

## RS3400MZ/8 RS3400MZ/12

Socket Set on magnetic Rail  
Steckschlüsselsatz auf Magnetschiene  
Jeu de douilles sur rail à aimant



RS3400MZ/8	8 Pieces Set/Rail 200mm	(g)
8, 10, 11, 12, 13, 14, 17, 19		320

RS3400MZ/12	12 Pieces Set/Rail 300mm	(g)
7, 8, 10, 11, 12, 13, 14, 15, 16, 17, 18, 19		490

## 3300XZ

6-point Sockets, Semi-Deep  
6-kant Steckschlüssel, mittel-lang  
Douilles, semi-profondes 6-pans

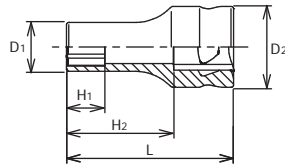

3300XZ (mm)	D <sub>1</sub> (mm)	D <sub>2</sub> (mm)	H <sub>1</sub> (mm)	H <sub>2</sub> (mm)	L (mm)	(g)	(pcs.)
7	10.3	17	8	23	35	23	10
8	11.5	17	9	23	35	24	10
10	14	17	11	23	35	26	10
11	15.3	17	12	23	35	28	10
12	16.5	17	13	23	35	29	10
13	17.8	17	14	23	35	32	10
14	19	17	16	23	35	34	10
15	20.2	18.2	16	23	35	40	10
16	21.3	19.3	16.5	23	35	45	10
17	22.5	20.5	16.5	23	35	50	10
18	23.6	21.6	16.5	23	35	56	10
19	24.8	22.8	18	23	35	60	10

## RS3300XZ/8 RS3300XZ/12

Socket Set on magnetic Rail  
Steckschlüsselsatz auf Magnetschiene  
Jeu de douilles sur rail à aimant



RS3300XZ/8	8 Pieces Set/Rail 200mm	(g)
8, 10, 11, 12, 13, 14, 17, 19		420

RS3300XZ/12	12 Pieces Set/Rail 300mm	(g)
7, 8, 10, 11, 12, 13, 14, 15, 16, 17, 18, 19		630

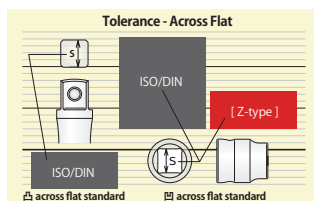
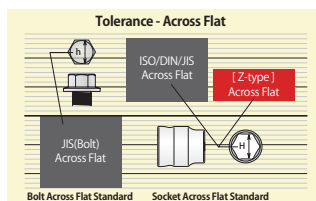

Manufacturing tolerance is precisely controlled to achieve a secure fitting.

## BALL HOLDING GROOVE

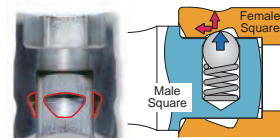

The inventive Ball Holding system of the Z-series allows a secure connection between Socket and Handle.

Die Werkzeuge der Z-Serie verfügen über spezielle Kugelfangrillen, die eine noch sicherere Verbindung zwischen Betätigungswerkzeug und Steckschlüssel gewährleisten.

La série Z dispose d'une rainure de fixation pour bille spéciale, qui améliore nettement la fixation entre douille et cliquet.

# 3/8"

Z-series  
Z-serie  
Series-Z

3300MZ (mm)	D <sub>1</sub> (mm)	D <sub>2</sub> (mm)	H <sub>1</sub> (mm)	H <sub>2</sub> (mm)	L (mm)	(g)	(pcs.)
7	10.3	17	8	41.5	55	29	10
8	11.5	17	9	41.5	55	34	10
10	14	17	11	41.5	55	43	10
11	15.3	17	12	41.5	55	45	10
12	16.5	17	13	41.5	55	49	10
13	17.8	17	14	41.5	55	52	10
14	19	17	16	41.5	55	55	10
15	20.2	18.2	16	40.5	55	65	10
16	21.3	19.3	17	40.5	55	74	10
17	22.5	20.5	18	40.5	55	83	10
18	23.6	21.6	19	39.5	55	90	10
19	24.8	22.8	20	39.5	55	95	10



**3300MZ** 6-point Deep Sockets  
6-kant-Steckschlüssel, lang  
Douilles longues 6-pans

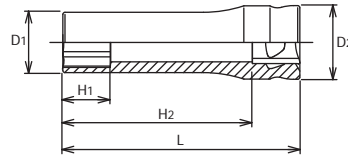

RS3300MZ/8	8 Pieces Set/Rail 200mm	(g)
8, 10, 11, 12, 13, 14, 17, 19		600

RS3300MZ/12	12 Pieces Set/Rail 300mm	(g)
7, 8, 10, 11, 12, 13, 14, 15, 16, 17, 18, 19		900

**RS3300MZ/8** Socket Set on magnetic Rail  
Steckschlüsselsatz auf Magnetschiene  
**RS3300MZ/12** Jeu de douilles sur rail à aimant



RS3X00MZ/12	12 Pieces Set/Rail 300mm	(g)
3400MZ	8, 10, 11, 12, 13, 14, 17, 19	550
3300MZ	8, 10, 12, 14	

**RS3X00MZ/12** Socket Set on magnetic Rail  
Steckschlüsselsatz auf Magnetschiene  
Jeu de douilles sur rail à aimant



3300CZ (mm)	D (mm)	H <sub>1</sub> (mm)	H <sub>2</sub> (mm)	L (mm)	(g)	(pcs.)
14	18.4	11	17	70	67	10
16	20.5	13	17	70	71	10
18	22.9	12	17	70	75	10
20.8	26.3	13.5	17	70	105	10

Slim & light weight body with smaller outside diameter for work in tight spaces.

Spring clip type spark plug sockets caused deforming the clip if it would be used with shallow engagement.



**3300CZ** Spark Plug Sockets with Spring Clips  
Zündkerzen-Schlüssel mit Haltefeder  
Douilles avec ressorts de retenues pour bougies

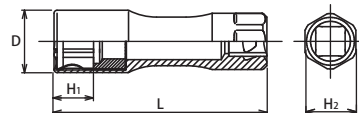

3305PZ (mm)	D (mm)	H <sub>1</sub> (mm)	H <sub>2</sub> (mm)	L (mm)	(g)	(pcs.)
14	17.9	8	17	70	56	10
16	20	8	17	70	55	10

Spark Plug Socket with Magnet, 12-pt. opening: size 14mm



The magnet could be broken with any impacts. Please handle with care.

**3305PZ** Spark Plug Socket with Magnet, 12-pt. opening  
Zündkerzensteckschlüssel mit Magnet, 12-kant  
Douille pour bougies, avec aimant, 12-pans

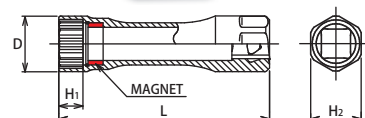

Z-SERIES  
HAND  
TITANIUM  
ACCESSORIES  
SCREWDRIVERS  
IMPACT  
SLEEVE-DRIVE  
PROTECTOR  
INDUSTRIAL  
AUTOMOTIVE  
MOTORCYCLE  
CONSTRUCTION  
SPARE PART



## 3441MZ

 Nut Grip Universal Sockets **Nut Grip®**  
Gelenk-Einsätze mit zweifacher Kugelhalterung  
Douilles articulées à billes de retenue



3441MZ (mm)	D <sub>1</sub> (mm)	D <sub>2</sub> (mm)	H (mm)	L (mm)	(g)	(pcs.)
8	12	17	4.5	41.5	45	10
10	14.5	17	4.5	41.5	47	10
12	16.8	17	5.5	42.5	50	10
13	17.8	17	5.5	42.5	53	10
14	19.5	17	7	44	55	10
17	23.4	17	8.5	45.5	66	10

## RS3441MZ/6

  Socket Set on magnetic Rail  
Steckschlüsselsatz auf Magnetschiene  
Jeu de douilles sur rail à aimant



RS3441MZ/6	6 Pieces Set/Rail 200mm	(g)
8, 10, 12, 13, 14, 17		435

## 3010MZ-50 / -75

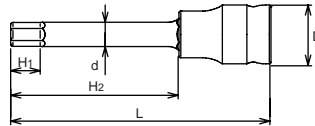

 Inhex Bit Sockets  
Steckschlüssel für Innensechskant-Schrauben  
Douilles tournevis pour vis 6-pans creux



3010MZ-50 (mm)	D (mm)	d (mm)	H <sub>1</sub> (mm)	H <sub>2</sub> (mm)	L (mm)	(g)	(pcs.)
3	17	4	8.5	23.5	50	28	10
4	17	5	8.5	23.5	50	29	10
5	17	6	8.5	23.5	50	30	10
6	17	7	8.5	23.5	50	35	10
7	17	-	8.5	23.5	50	38	10
8	17	-	-	23.5	50	40	10
10	17	-	-	23.5	50	50	10
12	19	-	-	23.5	50	70	10

3010MZ-75 (mm)	D (mm)	d (mm)	H <sub>1</sub> (mm)	H <sub>2</sub> (mm)	L (mm)	(g)	(pcs.)
3	17	6	8.5	48.5	75	33	10
4	17	6	8.5	48.5	75	35	10
5	17	6	8.5	48.5	75	36	10
6	17	7	8.5	48.5	75	41	10
7	17	7.9	8.5	48.5	75	45	10
8	17	-	-	48.5	75	48	10
10	17	-	-	48.5	75	65	10
12	19	-	-	48.5	75	90	10

## RS3010MZ/8-L50 RS3010MZ/8-L75

  Socket Set on magnetic Rail  
Steckschlüsselsatz auf Magnetschiene  
Jeu de douilles sur rail à aimant



RS3010MZ/8-L50	8 Pieces Set/Rail 200mm	(g)
3, 4, 5, 6, 7, 8, 10, 12		460

RS3010MZ/8-L75	8 Pieces Set/Rail 200mm	(g)
3, 4, 5, 6, 7, 8, 10, 12		530

## 3025Z-50 / -75

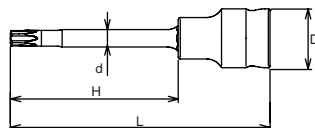

 TORX® Bit Sockets  
TORX® Bit-Steckschlüssel  
Douilles tournevis, TORX®



3025Z-50 (T)	D (mm)	d (mm)	H (mm)	L (mm)	(g)	(pcs.)
T10	17	3	23.5	50	27	10
T15	17	3.5	23.5	50	28	10
T20	17	3.9	23.5	50	28	10
T25	17	4.5	23.5	50	29	10
T27	17	5	23.5	50	30	10
T30	17	5.6	23.5	50	31	10
T40	17	6.7	23.5	50	35	10
T45	17	7.83	23.5	50	38	10
T50	17	8.90	23.5	50	48	10
T55	19	11.3	23.5	50	70	10

3025Z-75 (T)	D (mm)	d (mm)	H (mm)	L (mm)	(g)	(pcs.)
T20	17	4.5	48.5	75	32	10
T25	17	5	48.5	75	33	10
T27	17	5	48.5	75	33	10
T30	17	5.6	48.5	75	35	10
T40	17	6.7	48.5	75	41	10
T45	17	7.9	48.5	75	45	10
T50	17	8.9	48.5	75	55	10
T55	19	11.3	48.5	75	80	10

## RS3025Z/8-L50 RS3025Z/8-L75

  Socket Set on magnetic Rail  
Steckschlüsselsatz auf Magnetschiene  
Jeu de douilles sur rail à aimant



RS3025Z/8-L50	8 Pieces Set/Rail 200mm	(g)
T20, T25, T27, T30, T40, T45, T50, T55		450

RS3025Z/8-L75	8 Pieces Set/Rail 200mm	(g)
T20, T25, T27, T30, T40, T45, T50, T55		480

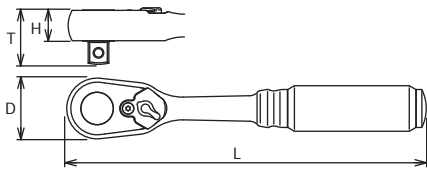

72

	D (mm)	T (mm)	H (mm)	L (mm)	(g)	(pce.)
2725Z-3/8	20.5	20.5	9.5	114	83	1

\* Renewal Kits → 2725RK-2(3/8) → P320

**2725Z-3/8**

Reversible Ratchet Short  
Knarre kurz, verstellbar  
Cliquet court, réversible

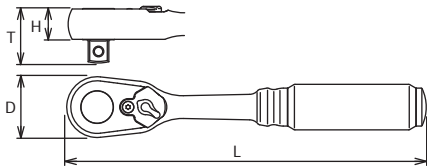

72

	D (mm)	T (mm)	H (mm)	L (mm)	(g)	(pce.)
2725Z-3/8 (L160)	20.5	20.5	9.5	160	120	1

\* Renewal Kits → 2725RK-2(3/8) → P320

⚠ 2725Z-3/8 (L160) have longer handle than standard, and can be loaded to excessive torque value. In the interest of your own safety always apply load evenly and progressively to avoid breakage and possible injury.

Sie haben einen längeren Griff als Standardprodukte und können mit einem übermäßigen Drehmoment belastet werden. Im Interesse Ihrer eigenen Sicherheit sollten Sie sie immer gleichmäßig und schrittweise belasten, um Brüche und mögliche Verletzungen zu vermeiden.

**2725Z-3/8 (L160)**

Reversible Ratchet (long)  
Knarre lang, verstellbar ⚠  
Cliquet long, réversible

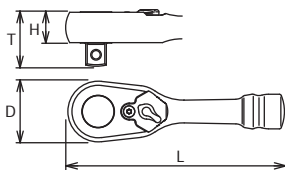

72

	D (mm)	T (mm)	H (mm)	L (mm)	(g)	(pce.)
3725ZS	28	24.5	13.7	100	157	1

\* Renewal Kits → 3725RK-2 → P320

**3725ZS**

Reversible Ratchet Short  
Knarre kurz, verstellbar  
Cliquet court, réversible

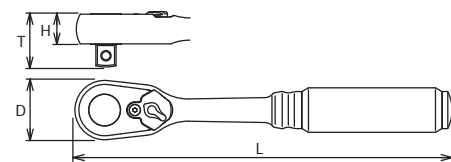

72

	D (mm)	T (mm)	H (mm)	L (mm)	(g)	(pce.)
3725Z	28	24.5	13.7	178	236	1

\* Renewal Kits → 3725RK-2 → P320

**3725Z**

Reversible Ratchet  
Knarre, verstellbar  
Cliquet, réversible



72

**3725Z-280**

Reversible Ratchet (long)  
Knarre lang, verstellbar ⚠  
Cliquet long, réversible



	D (mm)	T (mm)	H (mm)	L (mm)	(g)	(pce.)
3725Z-280	28	24.5	13.7	280	360	1

\* Renewal Kits → 3725RK-2 → P320

⚠ 3725Z-280 have longer handle than standard, and can be loaded to excessive torque value. In the interest of your own safety always apply load evenly and progressively to avoid breakage and possible injury.

Sie haben einen längeren Griff als Standardprodukte und können mit einem übermäßigen Drehmoment belastet werden. Im Interesse Ihrer eigenen Sicherheit sollten Sie sie immer gleichmäßig und schrittweise belasten, um Brüche und mögliche Verletzungen zu vermeiden.

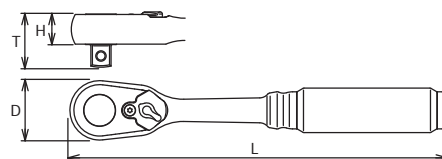

## 2725ZB-3/8

Reversible Ratchet with Quick Release Button  
Knarre, verstellbar mit Entriegelungsknopf  
Cliquet, réversible avec bouton de débrayage



	D (mm)	T (mm)	H (mm)	L (mm)	(g)	(pce.)
2725ZB-3/8	20.5	20.5	9.5	114	83	1

\* Renewal Kits → 2725BRK-1(3/8) → P320

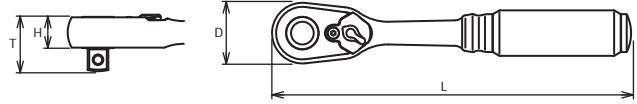

## 2725ZB-3/8 (L160)

Reversible Ratchet Long with Quick Release Button  
Knarre lang, verstellbar mit Entriegelungsknopf  
Cliquet long, réversible, avec bouton de déverrouillage



	D (mm)	T (mm)	H (mm)	L (mm)	(g)	(pce.)
2725ZB-3/8 (L160)	20.5	20.5	9.5	160	120	1

\* Renewal Kits → 2725BRK-1(3/8) → P320

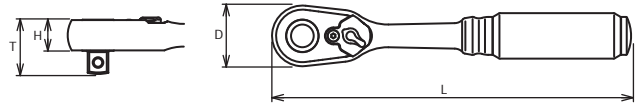

⚠ 2725ZB-3/8(L160) have longer handle than standard, and can be loaded to excessive torque value. In the interest of your own safety always apply load evenly and progressively to avoid breakage and possible injury.

Sie haben einen längeren Griff als Standardprodukte und können mit einem übermäßigen Drehmoment belastet werden. Im Interesse Ihrer eigenen Sicherheit sollten Sie sie immer gleichmäßig und schrittweise belasten, um Brüche und mögliche Verletzungen zu vermeiden.

## 3725ZSB

Reversible Ratchet Short with Quick Release Button  
Knarre, verstellbar mit Entriegelungsknopf  
Cliquet, réversible avec bouton de débrayage



	D (mm)	T (mm)	H (mm)	L (mm)	(g)	(pce.)
3725ZSB	28	24.5	13.7	100	157	1

\* Renewal Kits → 3725BRK-1 → P320

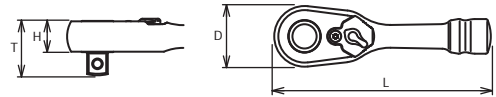

## 3725ZB

Reversible Ratchet with Quick Release Button  
Knarre, verstellbar mit Entriegelungsknopf  
Cliquet, réversible avec bouton de débrayage



	D (mm)	T (mm)	H (mm)	L (mm)	(g)	(pce.)
3725ZB	28	24.5	13.7	178	236	1

\* Renewal Kits → 3725BRK-1 → P320

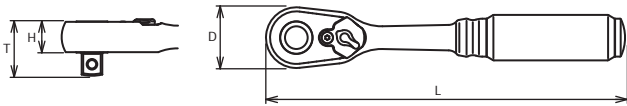

## 3725ZB-280

Reversible Ratchet Long with Quick Release Button  
Knarre lang, verstellbar mit Entriegelungsknopf  
Cliquet long, réversible, avec bouton de déverrouillage



	D (mm)	T (mm)	H (mm)	L (mm)	(g)	(pce.)
3725ZB-280	28	24.5	13.7	280	360	1

\* Renewal Kits → 3725BRK-1 → P320

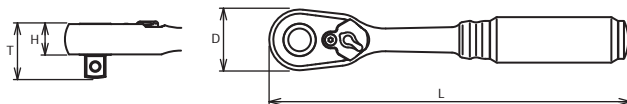

⚠ 3725ZB-280 have longer handle than standard, and can be loaded to excessive torque value. In the interest of your own safety always apply load evenly and progressively to avoid breakage and possible injury.

Sie haben einen längeren Griff als Standardprodukte und können mit einem übermäßigen Drehmoment belastet werden. Im Interesse Ihrer eigenen Sicherheit sollten Sie sie immer gleichmäßig und schrittweise belasten, um Brüche und mögliche Verletzungen zu vermeiden.

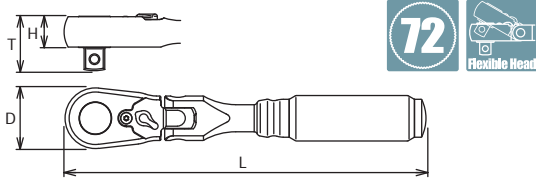

	D (mm)	T (mm)	H (mm)	L (mm)	(g)	(pce.)
2726Z-3/8	20.5	20.5	9.5	114	107	1

\* Renewal Kits → 2725RK-2(3/8) → P320

## 2726Z-3/8

Flexible Ratchet, Reversible (Short)  
Gelenk-Knarre kurz, verstellbar  
Cliquet articulé court, réversible

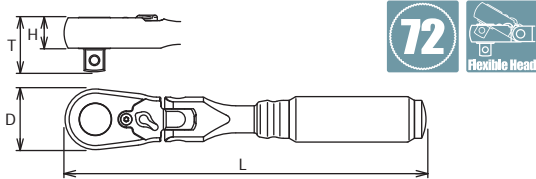

	D (mm)	T (mm)	H (mm)	L (mm)	(g)	(pce.)
2726Z-3/8 (L160)	20.5	20.5	9.5	160	130	1

\* Renewal Kits → 2725RK-2(3/8) → P320

## 2726Z-3/8 (L160)

Flexible Ratchet long, Reversible  
Gelenk-Knarre lang, verstellbar  
Cliquet articulé long, réversible



2726Z-3/8 (L160) have longer handle than standard, and can be loaded to excessive torque value. In the interest of your own safety always apply load evenly and progressively to avoid breakage and possible injury.

Sie haben einen längeren Griff als Standardprodukte und können mit einem übermäßigen Drehmoment belastet werden. Im Interesse Ihrer eigenen Sicherheit sollten Sie sie immer gleichmäßig und schrittweise belasten, um Brüche und mögliche Verletzungen zu vermeiden.

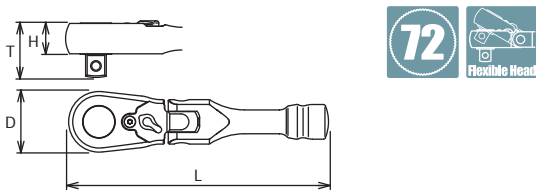

	D (mm)	T (mm)	H (mm)	L (mm)	(g)	(pce.)
3726ZS	28	24.5	13.7	120	196	1

\* Renewal Kits → 3725RK-2 → P320

## 3726ZS

Flexible Ratchet, Reversible (Short)  
Gelenk-Knarre kurz, verstellbar  
Cliquet articulé court, réversible

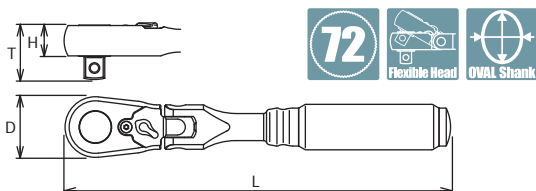

	D (mm)	T (mm)	H (mm)	L (mm)	(g)	(pce.)
3726Z	28	24.5	13.7	178	317	1

\* Renewal Kits → 3725RK-2 → P320

## 3726Z

Flexible Ratchet, Reversible  
Gelenk-Knarre lang, verstellbar  
Cliquet articulé, réversible



	D (mm)	T (mm)	H (mm)	L (mm)	(g)	(pce.)
3726Z-280	28	24.5	13.7	280	420	1

\* Renewal Kits → 3725RK-2 → P320

3726Z-280 have longer handle than standard, and can be loaded to excessive torque value. In the interest of your own safety always apply load evenly and progressively to avoid breakage and possible injury.

Sie haben einen längeren Griff als Standardprodukte und können mit einem übermäßigen Drehmoment belastet werden. Im Interesse Ihrer eigenen Sicherheit sollten Sie sie immer gleichmäßig und schrittweise belasten, um Brüche und mögliche Verletzungen zu vermeiden.

## 3726Z-280

Flexible Ratchet long, Reversible  
Gelenk-Knarre lang, verstellbar  
Cliquet articulé long, réversible

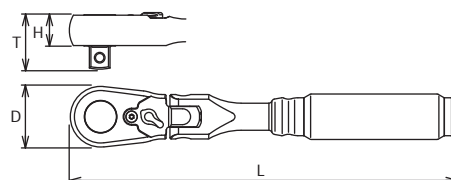

## 2726ZB-3/8

Flexible Ratchet, Reversible with Quick Release Button (Short)  
Gelenk-Knarre, verstellbar mit Entriegelungsknopf  
Cliquet, articulée, réversible avec bouton de débrayage



	D (mm)	T (mm)	H (mm)	L (mm)	(g)	(pce.)
2726ZB-3/8	20.5	20.5	9.5	114	107	1

\* Renewal Kits → 2725BRK-1(3/8) → P320

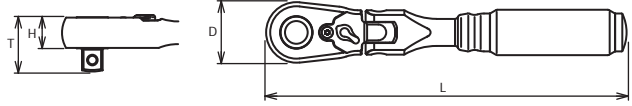

## 2726ZB-3/8 (L160)

Flexible Ratchet long, Reversible with Quick Release Button  
Gelenk-Knarre lang, verstellbar mit Entriegelungsknopf  
Cliquet long articulée, réversible avec bouton de débrayage



**!** 2726ZB-3/8(L160) have longer handle than standard, and can be loaded to excessive torque value. In the interest of your own safety always apply load evenly and progressively to avoid breakage and possible injury.

Sie haben einen längeren Griff als Standardprodukte und können mit einem übermäßigen Drehmoment belastet werden. Im Interesse Ihrer eigenen Sicherheit sollten Sie sie immer gleichmäßig und schrittweise belasten, um Brüche und mögliche Verletzungen zu vermeiden.

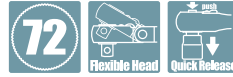

	D (mm)	T (mm)	H (mm)	L (mm)	(g)	(pce.)
2726ZB-3/8 (L160)	20.5	20.5	9.5	160	130	1

\* Renewal Kits → 2725BRK-1(3/8) → P320

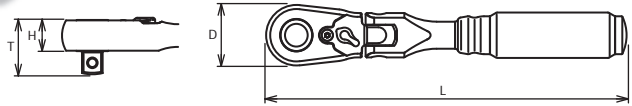

## 3726ZSB

Flexible Ratchet, Reversible with Quick Release Button (Short)  
Gelenk-Knarre, verstellbar mit Entriegelungsknopf  
Cliquet, articulée, réversible avec bouton de débrayage



	D (mm)	T (mm)	H (mm)	L (mm)	(g)	(pce.)
3726ZSB	28	24.5	13.7	120	196	1

\* Renewal Kits → 3725BRK-1 → P320

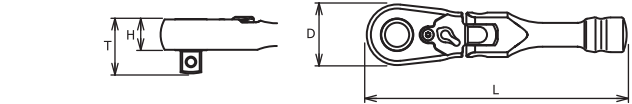

## 3726ZB

Flexible Ratchet, Reversible with Quick Release Button  
Gelenk-Knarre, verstellbar mit Entriegelungsknopf  
Cliquet, articulée, réversible avec bouton de débrayage

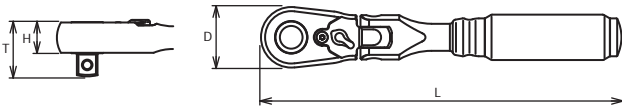

	D (mm)	T (mm)	H (mm)	L (mm)	(g)	(pce.)
3726ZB	28	24.5	13.7	178	317	1

\* Renewal Kits → 3725BRK-1 → P320

## 3726ZB-280

Flexible Ratchet long, Reversible with Quick Release Button  
Gelenk-Knarre lang, verstellbar mit Entriegelungsknopf  
Cliquet long articulée, réversible avec bouton de débrayage

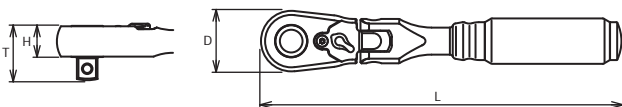

	D (mm)	T (mm)	H (mm)	L (mm)	(g)	(pce.)
3726ZB-280	28	24.5	13.7	280	420	1

\* Renewal Kits → 3725BRK-1 → P320

**!** 3726ZB-280 have longer handle than standard, and can be loaded to excessive torque value. In the interest of your own safety always apply load evenly and progressively to avoid breakage and possible injury.

Sie haben einen längeren Griff als Standardprodukte und können mit einem übermäßigen Drehmoment belastet werden. Im Interesse Ihrer eigenen Sicherheit sollten Sie sie immer gleichmäßig und schrittweise belasten, um Brüche und mögliche Verletzungen zu vermeiden.



## 3768Z-250 3768Z-400

Hinge Handle  
Gelenkgriff  
Poignée articulée



	D (mm)	L (mm)	(g)	(pcs.)
3768Z-250	20.5	250	309	5
3768Z-400	20.5	400	500	2

\* Renewal Kits → 3768ZRK → P321

3768Z-400 have longer handle than standard, and can be loaded to excessive torque value. In the interest of your own safety always apply load evenly and progressively to avoid breakage and possible injury.

Sie haben einen längeren Griff als Standardprodukte und können mit einem übermäßigen Drehmoment belastet werden. Im Interesse Ihrer eigenen Sicherheit sollten Sie sie immer gleichmäßig und schrittweise belasten, um Brüche und mögliche Verletzungen zu vermeiden.

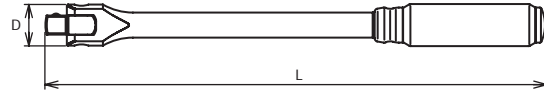

	D (mm)	d (mm)	L (mm)	(g)	(pcs.)
3760Z-75	17.5	11	75	66	10
3760Z-125	17.5	11	125	103	10
3760Z-250	17.5	11	250	195	5

## 3760Z

Extension Bars  
Verlängerungen  
Rallonges

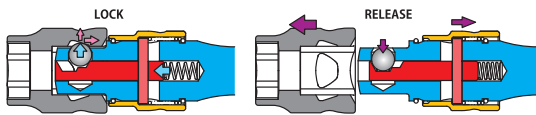
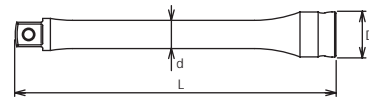

## 3760LZ

Locking Extension Bars  
Verriegelbare Verlängerungen  
Barres d'extension verrouillables

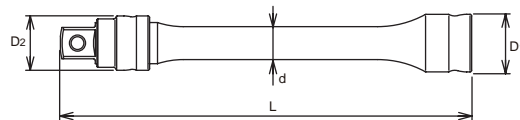

	D <sub>1</sub> (mm)	D <sub>2</sub> (mm)	d (mm)	L (mm)	(g)	(pcs.)
3760LZ-75	17.5	16.5	10	75	75	10
3760LZ-125	17.5	16.5	10	125	105	10
3760LZ-250	17.5	16.5	10	250	185	5

You may not hold the sliding part while moving to avoid heating up by friction and reduction by wear.

Bitte das gleitende Teil während der Bewegung nicht festhalten, um eine Erhitzung durch Reibung und durch Verschleiß zu vermeiden.

Veuillez ne pas tenir la pièce coulissante pendant le mouvement, afin d'éviter un échauffement dû à la friction et à l'usure.

	D (mm)	L (mm)	(g)	(pcs.)
3771Z	18	42.5	44	10



## 3771Z

Universal Joint  
Gelenk-Einsatz  
Joint articulé

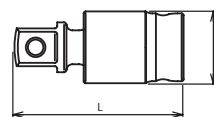
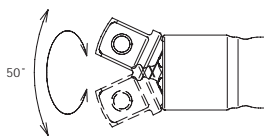

	D (mm)	L (mm)	(g)	(pcs.)
3772Z	17	65	76	10

## 3772Z

Universal Double Joint  
Doppelgelenk-Einsatz  
Joint articulé double

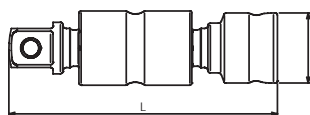
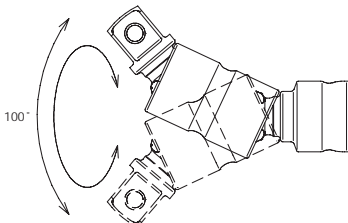

Z-series  
Z-serie  
Series-Z

# 3/8"

Z-SERIES  
HAND  
TITANIUM  
SCREWDRIVERS ACCESSORIES  
IMPACT  
SLEEVE-DRIVE  
PROTECTOR  
INDUSTRIAL  
AUTOMOTIVE  
CONSTRUCTION MOTORCYCLE  
SPARE PART

**3756Z** Quick Spinner  
Rändel-Drehscheibe  
Lanceur

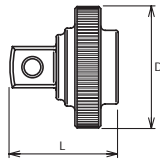

	D (mm)	L (mm)	(g)	(pcs.)
<b>3756Z</b>	28	25	40	10

Outside diameter is smaller compared to standard 3756.  
Ideal for working in combination with 3725Z

Der Außendurchmesser ist kleiner als bei Standard 3756.  
Ideal für die Verwendung in Kombination mit der Knarre 3725Z.



**3756ZS** Quick Spinner  
Rändel-Drehscheibe  
Lanceur

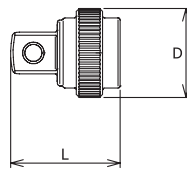

	D (mm)	L (mm)	(g)	(pcs.)
<b>3756ZS</b>	20.3	25	26	10

Ideal for working in combination with 2725Z-3/8 and 2726Z-3/8.

**3756Z-1/2** Quick Spinner, Adaptor  
Rändel-Drehscheibe als Adaptor  
Lanceur, adapteur

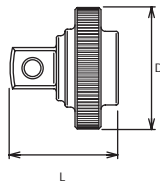

	D (mm)	L (mm)	(g)	(pcs.)
<b>3756Z-1/2</b>	28	29	52	10

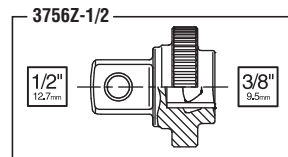

**3322AZ-75** Extension Adaptor  
Verlängerungsadapter  
Reduction adapteur-rallonge

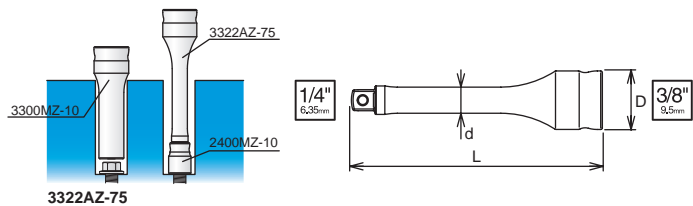

	D (mm)	d (mm)	L (mm)	(g)	(pcs.)
<b>3322AZ-75</b>	17.5	7.8	75	42	10





<b>3285Z</b>		26 Pieces Set/△=2,100g	
FOAM TRAY:W390xT180xH25			
Sockets		Accessories	
	<b>3400MZ</b> 6-pt. Sockets 5.5, 6, 7, 8, 10, 12, 13, 14, 17, 19, 21, 22		<b>3725Z</b>
	<b>3300MZ</b> 6-pt. Deep Sockets 8, 10, 12, 14		<b>3756Z</b>
	<b>3300CZ</b> Spark Plug Sockets 14, 16, 20.8		<b>3771Z</b>
			<b>3768Z-250</b>
			<b>3760Z-75</b>
			<b>3760Z-125</b>
			<b>3760Z-250</b>

**3285Z** Set in PE-foam tray  
Steckschlüsselsatz in Weichschaumeinlage  
Set disposé dans boîte de rangement en mousse souple



<b>3285ZA</b>		15 Pieces Set/△=750g	
FOAM TRAY:W300xT90xH25			
Sockets		Accessories	
	<b>3400MZ</b> 6-pt. Sockets 5.5, 6, 7, 8, 10, 12, 13, 14, 17, 19, 21, 22		<b>3725Z</b>
			<b>3756Z</b>
			<b>3771Z</b>

**3285ZA** Set in PE-foam tray  
Steckschlüsselsatz in Weichschaumeinlage  
Set disposé dans boîte de rangement en mousse souple



<b>3286Z</b>		21 Pieces Set/△=2,600g	
BLACK METAL CASE:W415xH120xT50mm			
Sockets		Accessories	
	<b>3400MZ</b> 6-pt. Sockets 7, 8, 10, 11, 12, 13, 14, 15, 16, 17, 18, 19, 21, 22		<b>3725Z</b>
			<b>3756Z</b>
			<b>3771Z</b>
			<b>3768Z-250</b>
			<b>3760Z-75</b>
			<b>3760Z-125</b>
			<b>3760Z-250</b>

**3286Z** Set in PE-foam tray  
Steckschlüsselsatz in Weichschaumeinlage  
Set disposé dans boîte de rangement en mousse souple



<b>3285ZE</b>		9 Pieces Set/△=600g	
Rail 200mm/CARDBOARD BOX			
Sockets		Accessories	
	<b>3400MZ</b> 6-pt. Sockets 8, 10, 12, 13, 14, 17, 19		<b>3725Z</b>
			<b>3756Z</b>

**3285ZE** Socket Set on magnetic Rail  
Steckschlüsselsatz auf Magnetschiene  
Jeu de douilles sur rail à aimant



## 4400MZ



6-point Sockets  
6-kant Steckschlüssel  
Douilles 6-pans

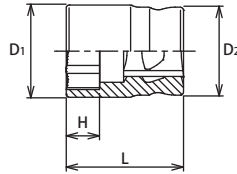

4400MZ (mm)	D <sub>1</sub> (mm)	D <sub>2</sub> (mm)	H (mm)	L (mm)	(g)	(pcs.)
8	12.9	20.6	4.5	26	30	10
10	15	20.6	4.5	26	31	10
12	17	20.6	5.5	27	32	10
13	18.3	21.5	6.5	28	40	10
14	19.5	21.5	6.5	28	40	10
16	22	21.5	7.5	29	43	10
17	23	22.5	7.5	29	49	10
18	24.1	23.7	7.5	29	56	10
19	25.3	24.4	9.5	29	62	10
21	27.6	26.3	10.5	29	76	10
22	28.8	27.5	11	29	83	10
24	31.1	29.2	12	29	96	5
27	34.6	32.2	13.5	30	124	5
30	38.1	35.2	14.5	31	156	5
32	40.4	36.8	15.5	32	178	5

## RS4400MZ/10



Socket Set on magnetic Rail  
Steckschlüsselsatz auf Magnetschiene  
Jeu de douilles sur rail à aimant



RS4400MZ/10	10 Pieces Set/Rail 300mm	(g)
10, 12, 13, 14, 17, 19, 21, 22, 24, 27		830

## 4725Z

Reversible Ratchet  
Knarre, verstellbar  
Cliquet, réversible

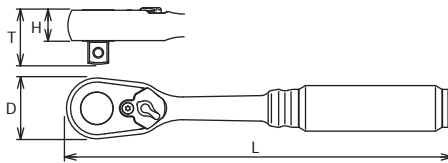

72

	D (mm)	T (mm)	H (mm)	L (mm)	(g)	(pce.)
4725Z	36.5	32.8	18.2	253	590	1

\* Renewal Kits → 4725RK-2 → P320

## 4725ZB

Reversible Ratchet with Quick Release Button  
Knarre, verstellbar mit Entriegelungsknopf  
Cliquet, réversible avec bouton de débrayage

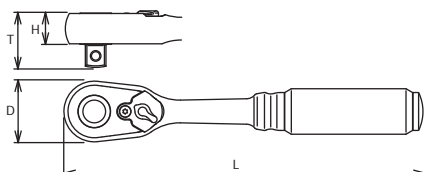

72



	D (mm)	T (mm)	H (mm)	L (mm)	(g)	(pce.)
4725ZB	36.5	32.8	18.2	253	595	1

\* Renewal Kits → 4725BRK-1 → P320

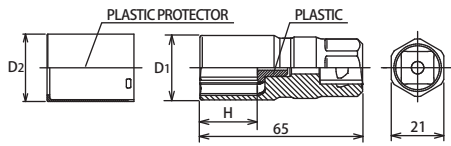

## 4300PMZ-65

Wheel Nut Socket with Plastic Protector  
Radmuttern Steckschlüssel mit Kunststoff Hülse  
Douilles pour écrous de roue avec protection en plastique



4300PMZ-65 (mm)	D <sub>1</sub> (mm)	D <sub>2</sub> (mm)	H (mm)	Colour	(g)	(pcs.)
17	23.7	25.2	21	Blue	135	10
19	25.7	27.2	23	Red	150	10
21	27.5	29	25	Yellow	155	10
22	29	30.5	26	White	165	10

⚠ Please note that thin walled design is only for wheel nut work and Torque rating is limited.



FREE-TURN  
CROSS WRENCH

## 4711XZ

Spinning Cross Wrench  
T-Griff für die Radmuttermontage  
Poignée coulissante pour montage des écrous à roue

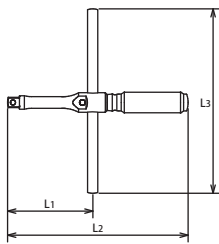

	L1 (mm)	L2 (mm)	L3 (mm)	(g)	(pcs.)
4711XZ	133	264	350	915	1



RENEWAL KIT FOR  
HINGE HANDLE

OVAL SHAPE  
SHANK

## 4768Z-430

Hinge Handle  
Gelenkgriff  
Poignée articulée



	D (mm)	L (mm)	(g)	(pcs.)
4768Z-430	28	430	720	2

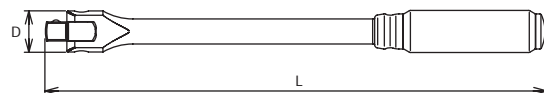

\* Renewal Kits → 4768ZRK → P321

⚠ 4768Z-430 have longer handle than standard, and can be loaded to excessive torque value. In the interest of your own safety always apply load evenly and progressively to avoid breakage and possible injury.

Sie haben einen längeren Griff als Standardprodukte und können mit einem übermäßigen Drehmoment belastet werden. Im Interesse Ihrer eigenen Sicherheit sollten Sie sie immer gleichmäßig und schrittweise belasten, um Brüche und mögliche Verletzungen zu vermeiden.

Z-SERIES  
HAND  
TITANIUM  
SCREWDRIVERS ACCESSORIES  
IMPACT  
SLEEVE-DRIVE  
PROTECTOR  
INDUSTRIAL  
AUTOMOTIVE  
MOTORCYCLE  
CONSTRUCTION  
SPARE PART

## 4760Z

Extension Bars  
Verlängerungen  
Rallonges

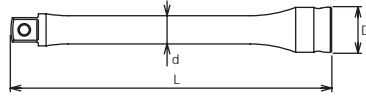

	D (mm)	d (mm)	L (mm)	(g)	(pcs.)
4760Z-125	23	14.3	125	180	5
4760Z-250	23	14.3	250	340	5

## 4760LZ

Locking Extension Bars  
Verriegelbare Verlängerungen  
Barres d'extension verrouillables

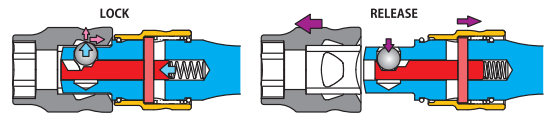
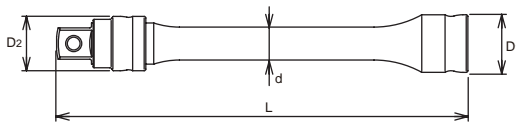

	D <sub>1</sub> (mm)	D <sub>2</sub> (mm)	d (mm)	L (mm)	(g)	(pcs.)
4760LZ-125	23	20.5	13	125	186	5
4760LZ-250	23	20.5	13	250	346	5

You may not hold the sliding part while moving to avoid heating up by friction and reduction by wear.

Bitte das gleitende Teil während der Bewegung nicht festhalten, um eine Erhitzung durch Reibung und durch Verschleiß zu vermeiden.

Veuillez ne pas tenir la pièce coulissante pendant le mouvement, afin d'éviter un échauffement dû à la friction et à l'usure.

## 4771Z

Universal Joint  
Gelenk-Einsatz  
Joint articulé



UNIVERSAL JOINT

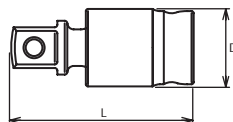
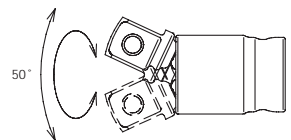

	D (mm)	L (mm)	(g)	(pcs.)
4771Z	23.7	55.8	100	10

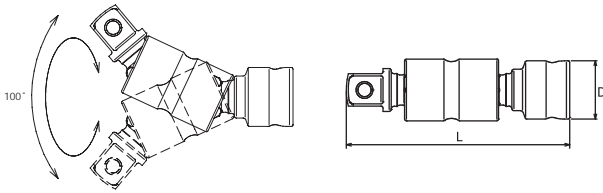

	D (mm)	L (mm)	(g)	(pcs.)
4772Z	23.7	87.2	170	5

**4772Z** Universal Double Joint  
Doppelgelenk-Einsatz  
Joint articulé double



RSX772Z/3	3 Pieces Set/Rail 200mm	(g)
2772Z, 3772Z, 4772Z		290

1/4" + 3/8" + 1/2"

**RSX772Z/3**

Universal Joints 1/4", 3/8", 1/2" 3 pcs set on rail  
Doppelgelenk-Einsätze 1/4", 3/8", 1/2" 3teiliger Satz auf Schiene  
Douilles à double articulation 1/4", 3/8", 1/2" Jeu de 3 pièces sur rail



	D (mm)	L (mm)	(g)	(pcs.)
4756Z	36.3	33.5	84	10

**4756Z** Quick Spinner  
Rändel-Drehscheibe  
Lanceur

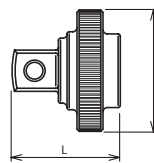

## 4285Z

Set in Foam tray  
Steckschlüsselsatz in Weichschaumeinlage  
Set disposé dans boîte de rangement en mousse souple

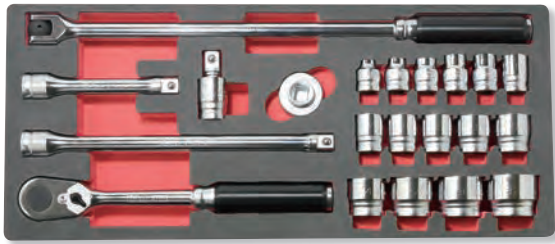

4285Z		21 Pieces Set/△=4,800g	
METAL CASE:W445xT190xH50			
Sockets		Accessories	
<b>4400MZ</b> 6-pt. Sockets 8, 10, 12, 13, 14, 16, 17, 18, 19, 21, 22, 24, 27, 30, 32		<b>4725Z</b>	
		<b>4756Z</b>	
		<b>4771Z</b>	
		<b>4768Z-430</b>	
		<b>4760Z-125</b>	
		<b>4760Z-250</b>	

## 4285ZE

Socket Set on magnetic Rail  
Steckschlüsselsatz auf Magnetschiene  
Jeu de douilles sur rail à aimant



4285ZE		11 Pieces Set/△=1,380g	
Rail 300mm/CARDBOARD BOX			
Sockets		Accessories	
<b>4400MZ</b> 6-pt. Sockets 10, 12, 13, 14, 17, 19, 21,22, 24		<b>4725Z</b>	
		<b>4756Z</b>	

## RSAL200 RSAL300

Magnetic Rail with retaining clips  
Magnetschiene mit Halteklammern  
Rail à aimant avec clips de maintien



RSAL200		RAIL (mm)	CLIP (pcs.)	(g)	(pce.)
1/4x12	1/4"	200	12	125	1
3/8x8	3/8"	200	8	130	1

RSAL300		RAIL (mm)	CLIP (pcs.)	(g)	(pce.)
3/8x12	3/8"	300	12	180	1
1/2x10	1/2"	300	10	190	1

## RSAL CLIP.P/5

Magnetic Rails and retaining Clips, bulk  
Magnetschiene und Halteklammern, lose  
Rail à aimant avec clips de maintien, en vrac



	RAIL (mm)	(g)	(pce.)
RSAL200	200	110	1
RSAL300	300	145	1
RSAL400	400	210	1

CLIP.P/5		(g)	(pce.)
1/4	1/4"	10	5
3/8	3/8"	13	5
1/2	1/2"	20	5